



ACS 300

User's Manual

ACS 300 AC Drives for Speed Control of
1/2 Hp to 15 Hp Squirrel Cage Motors

ACS 300 AC Drives for Speed Control of 1/2 Hp to 15 Hp Squirrel Cage Motors

User's Manual

ACS300-US-04
Effective: 1/1/1998
Valid from software version CDS02E.1 / CDH02E.1

© 1996 ABB Industrial Systems All Rights Reserved.

Safety Instructions

Overview

This chapter states the safety instructions which must be followed when installing, operating and servicing the ACS 300. If neglected, physical injury and death may follow, or damage may occur to the AC drive, the motor and driven equipment. The material in this chapter must be studied before attempting any work on or with the unit.

Warnings and Notes

This manual distinguishes two sorts of safety instructions. Warnings are used to inform of conditions which can, if proper steps are not taken, lead to a serious fault condition, physical injury and death. Notes are used when the reader is required to pay special attention or when there is additional information available on the subject. Notes are less crucial than warnings, but should not be disregarded.

Warnings

Readers are informed of situations that can result in serious physical injury and/or serious damage to equipment with the following symbols:



Dangerous Voltage Warning warns of situations in which a high voltage can cause physical injury and/or damage equipment. The text next to this symbol describes ways to avoid the danger.



General Warning warns of situations which can cause physical injury and/or damage equipment by means other than electrical. The text next to this symbol describes ways to avoid the danger.

Safety Instructions

Notes Readers are notified of the need for special attention or additional information available on the subject with the following symbols:

CAUTION! **Caution** emphasizes a matter in order to draw special attention to it.

Note! **Note** gives additional information or points out more information available on the subject.

General Safety Instructions

These safety instructions are intended for all work on the ACS 300.



WARNING! All electrical installation and maintenance work on the ACS 300 should be carried out by qualified electricians.

The ACS 300 and adjoining equipment must *always* be properly grounded. The motor and all accessories must be grounded through ACS 300.

All the ACS 300 units include capacitors connected between the main circuit and the frame. These capacitors increase the ground leakage current through the ground connection to the power line and may cause some ground fault circuit breakers to trip.



WARNING! All electrical installation and maintenance work on the ACS 300 should be carried out by qualified electricians.

Do not attempt any work on a powered ACS 300. After switching off the power, always allow the DC bus capacitors 5 minutes to discharge before working on the AC drive, the motor or the motor wiring. It is good practice to check (with a voltage indicating instrument) that the AC drive is in fact unpowered before beginning work.

Safety Instructions

WARNING! The ACS 300 motor cable terminals are at a dangerously high voltage when power is applied regardless of motor operation.

There can be dangerous voltages inside the ACS 300 from external control circuits when the ACS 300 AC line power is shut off. Exercise appropriate care when working with the unit. Negligence to these instructions can cause physical injury and death.



WARNING! The ACS 300 may introduce electric motors, drive train mechanisms and driven machines to an extended operating range. It should be confirmed that all equipment is suitable for these conditions.



Do not make any voltage tolerance tests (Hi Pot or Meggar) on any part of the ACS 300. Disconnect motor wires from the ACS 300 before making any such tests on the motor or motor wiring.

Failure to follow these instructions can result in permanent damage to the ACS 300.



WARNING! Certain parameter settings and external control signals may cause the ACS 300 to start up automatically after an input power failure.

The motor rotational direction can be locked to forward only by using the DIR parameter. See page 64 for more details.

Mechanical faults on the motor, power failure or other faults may cause stoppages. Correcting the fault may cause the motor to restart. Take all necessary precautions to ensure personnel safety and to avoid damage to equipment and property before motor restart.

*Safety Instructions***Disconnect Device**

A supply disconnecting device shall be installed in each supply, by which the electric parts of ACS 300 can be disconnected from the AC line during installation and maintenance work. The disconnecting device shall conform to the requirements of all applicable electrical codes. The supply disconnecting device shall be locked in the open position while installation and maintenance work is going on.

Emergency Stop Devices

The ACS 300 start/stop control circuitry consists of electronic components. An additional hardwired electromechanical stop circuit is required to remove AC line power from the drive if there are hazards of personnel accidentally contacting the moving parts of the driven machinery or if there is any other potential hazard that requires the installation of emergency stop devices. When the drive is stopped by disconnecting power, no braking is available and the motor will coast to a stop. If emergency stop braking is required, a spring set friction brake should be used.

Table of Contents

Safety Instructions

Overview	v
Warnings and Notes	v
General Safety Instructions	vi
Disconnect Device	viii
Emergency Stop Devices	viii

Chapter 1 - Overview of This Manual

Introduction	1
Intended Audience	1
How to Use This Manual	2
Limitation of Liability	3
Delivery Checks	4
Identification Labels	5
General Information About ACS 300	6

Chapter 2 - Mechanical Installation

Cooling	11
Mounting	12

Chapter 3 - Power Connections

Line Voltage Ratings	15
Power Wiring Requirements	15
Input Power Wiring	16
Motor Wiring	16
Insulation Checks	17
Grounding and Ground Faults	17

Chapter 4 - Control Connections

Control Locations	21
Control Wiring	21
Parameter Lock	23
Analog Input	24
Digital Inputs	25
Relay Outputs	33

*Table of Contents***Chapter 5 - Start-up**

Flowchart Commissioning Checklist	35
Checking the Parameters	36

Chapter 6 - Control and Parameter Logic

Control Panel	37
Panel Operation	39
Parameter Logic	42
Example	43

Chapter 7 - Drive Parameters

Parameter Tables	45
Detailed Parameter Information	48

Chapter 8 - Fault Tracing

Fault Indications	73
Fault Resetting	73
Fault Memory	73
Fault Tracing	74

Chapter 9 - Technical Data

Incoming Power	79
Output Power	79
Environmental Limits	80
External Control Connections	80
Protection	82
Accessories	82

Appendix A - Product Conformity in EEA

General Information	83
Electromagnetic Compatibility, EMC	83
Low Voltage Directive	84
Machinery Directive	85
Mains Cable	86
Motor Cable	87
Cable Installation	87

Chapter 1 - Overview of This Manual

Introduction

This chapter describes the purpose and the contents of this manual and explains the conventions used within. This chapter also identifies the intended audience and lists the related documentation.

The purpose of this manual is to provide you with the information necessary to install, start-up, operate and service an ACS 300 AC drive. This manual also describes features and functions of the AC drive, as well as requirements for external control connections, cabling, cable sizes and routing.

Intended Audience

This manual is intended for those who are responsible for installing, commissioning and servicing the ACS 300 AC drive. The audience is expected to:

- Have a basic knowledge of physical and electrical fundamentals, electrical wiring practices, electrical components and electrical schematic symbols.
- Have no prior experience of ABB products.
- Have no prior experience of the ACS 300 family.
- Have no prior experience of installing, commissioning, operating and servicing the ACS 300.

With the help of this manual you will be able to install, start-up operate and service the ACS 300.

Chapter 1 - Overview of This Manual

How to Use This Manual

Safety instructions are at the beginning of this manual. In this chapter the general instructions are stated and various warnings and notations are described.

Chapter 1 - Introduction to This Manual, the chapter you are reading now, contains general information on the purpose and contents of this manual.

Chapter 2 - Mechanical Installation, describes the requirements and provides instructions for the mechanical mounting of ACS 300 and the optional keypad control panel.

Chapter 3 - Power Connections, describes the requirements and provides instructions for connecting wiring for input power, output power to the motor, dynamic braking components and grounding the equipment.

Chapter 4 - Control Connections, describes how ACS 300 can be controlled by the optional keypad control panel or by external control signals. Instructions are provided for connecting the external control wiring.

Chapter 5 - Commissioning, includes safety precautions, start-up check list and keypad control tests.

Chapter 6 - Control and Parameter Logic, describes how to use the control panel.

Chapter 7 - Drive Parameters, lists and explains the drive parameters.

Chapter 8 - Fault Tracing, describes ACS 300 fault indications, fault memory and how to trace faults.

Chapter 9 - Technical Data, lists ACS 300 technical specifications and other useful data.

Appendix A - Product Conformity in EEA, provides information regarding the installation of the ACS 300 in conformance with the requirements of the European Economic Area.

*Chapter 1 - Overview of This Manual***Limitation of Liability**

IN NO EVENT SHALL ABB, ITS SUPPLIERS OR SUB-CONTRACTORS BE LIABLE FOR SPECIAL, INDIRECT, INCIDENTAL OR CONSEQUENTIAL DAMAGES, WHETHER IN CONTRACT, GUARANTEE, TORT, NEGLIGENCE, STRICT LIABILITY OR OTHERWISE, including, but not limited to loss of profits or revenue, loss of use of the Equipment or any associated equipment, cost of capital, cost of substitute equipment, facilities or services, downtime costs, delays, or claims of customers of the Purchaser or other third parties for such or other damages. ABB's liability on any claim whether in contract, warranty, negligence, tort, strict liability, or otherwise for any loss or damage arising out of, connected with, or resulting from the contract or the performance or breach thereof, or from the design, manufacture, sale, delivery, resale, repair, replacement, installation, technical direction of installation, inspection, operation or use of any equipment covered by or in connection therewith, shall in no case exceed the purchase price of the Equipment or part thereof or services which give rise to the Claim.

All clauses of action against ABB arising out of or relating to the contract or the performance or breach hereof shall expire unless brought within one year of the time of accrual thereof.

In no event, regardless of cause, shall ABB assume responsibility for or be liable for penalties or penalty clauses of any description or for indemnification of customer or others for costs, damages, or expenses each arising out of or related to the goods or services of the order.

Your local distributor or ABB office may hold different guarantee details, which are specified in the sales terms, conditions, or guarantee terms. These terms are available at request.

If you have any questions concerning your ABB AC drive, please contact the local distributor or ABB office. The technical data, information and specifications are valid at the time

Chapter 1 - Overview of This Manual

of printing. The manufacturer reserves the right to modifications without prior notice.

Delivery Checks

Please verify that the delivery is complete and correct, when you receive the ACS 300. Verify also that the AC drive is undamaged. In the event of damage, please contact the carrier involved or the supplier. If the delivery is not in compliance with the order, please contact the supplier immediately.

ACS 300 is always delivered with the dummy control panel insert installed in the cover.

A drip shield is provided to prevent falling dirt and dripping fluids from entering the ventilation slots at the top of the enclosure. The enclosure rated NEMA 1 with the drip shield installed.

Manufacturing date is determined by unit's serial number in the name plate. First digit shows the last figure of the year. Digits two and three tell the manufacturing week. For example 5220053 where 5 means 1995 and 22 manufacturing week and the rest of the digits are for internal use.

Inspection Labels Every ACS 300 has a Pass sticker to show that it is inspected and qualified.

Chapter 1 - Overview of This Manual

Identification Labels

Type Designation

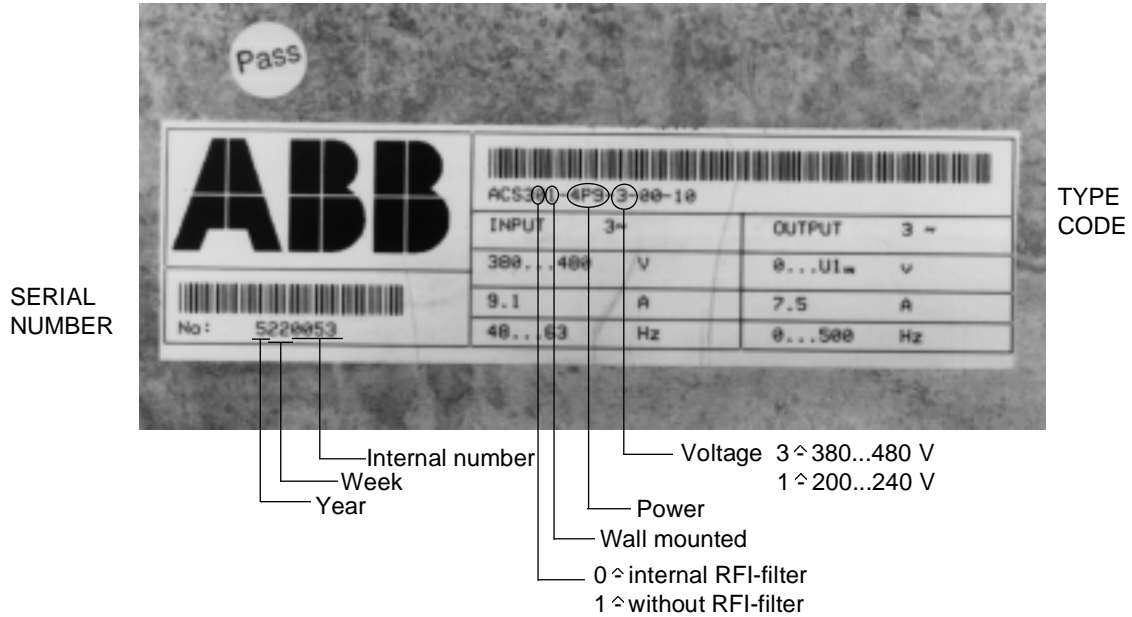

Figure 1-1 Type designation of the ACS 300 frame sizes R0 and R1 (code printed on the nameplate located at the right side of the heatsink).

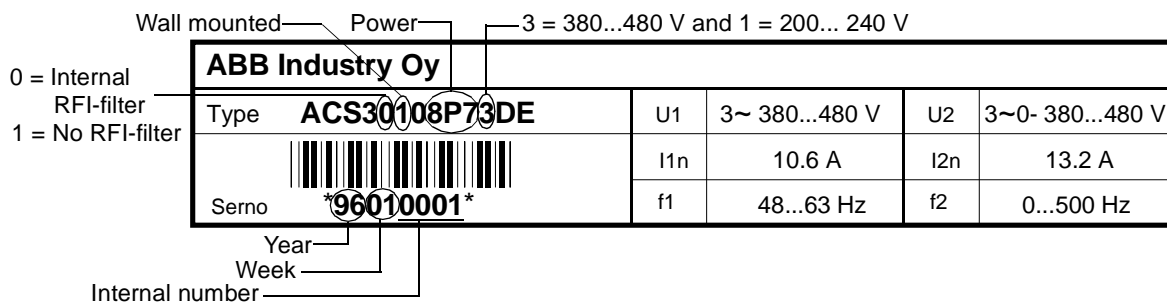

Figure 1-2 Type designation of the ACS 300 frame size R2.

*Chapter 1 - Overview of This Manual***General Information
About ACS 300**

Overview of ACS 300 Product Family ACS 300 is a PWM AC drive using the latest technology. Concept ACS 300 refers to ACS 300 product family. There are options available besides the basic unit. For instance keypad control panel, keypad control panel remote mounting kit, serial communication adapter, braking resistor and braking chopper. Ask for related documents.

The ACS 300 must always be connected to a three phase motor.

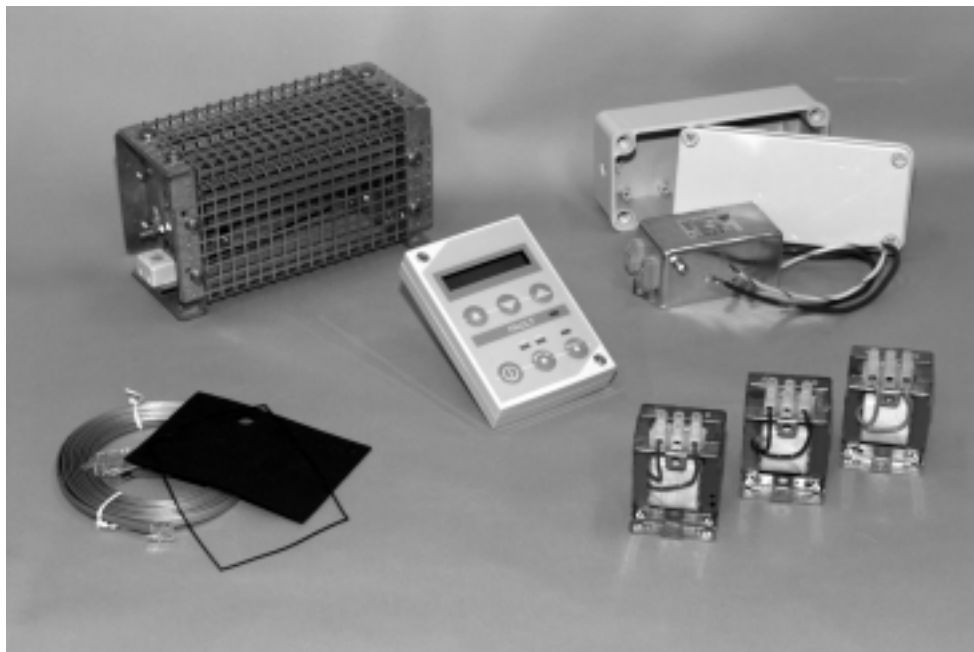

Figure 1-3 ACS 300 options.

Chapter 1 - Overview of This Manual

Type Series Table 1-1 and Table 1-2 list the principal input and output ratings for each of the various ACS 300 type designations. The frame size assignments R0, R1 and R2 are used to identify the enclosure sizes and other characteristics of the various models.

Table 1-1 ACS 300 AC drive types for 50 Hz and 60 Hz supplies.
Input power supply 200 to 240 V.

Type designation ³⁾	Frame	Rated input current ²⁾		Output current		Maximum permissible rated motor power		Weight	
		1-phase I ₁ [A]	3-phase I ₁ [A]	Rated current I _N [A]	Short-term overload current I _{OVER} [A] ¹⁾	P _N [Hp]	P _N [kW]	[lbs.]	[kg]
ACS 311-1P1-1	R0	6.6	-	3.0	4.5	1/2	0.55	6.8	3.1
ACS 311-1P6-1	R0	8.9	-	4.3	6.5	1	0.75	6.8	3.1
ACS 301-2P1-1	R1	12.2	-	5.5	8.3	1-1/2	1.1	10.1	4.6
ACS 311-2P1-1	R1	12.2	8.4	5.5	8.3	1-1/2	1.1	10.1	4.6
ACS 301-2P7-1	R1	15.7	-	7.1	10.7	2	1.5	10.1	4.6
ACS 311-2P7-1	R1	15.7	9.8	7.1	10.7	2	1.5	10.1	4.6
ACS 301-4P1-1	R1	22.4	-	10.7	13.0	3	2.2	10.1	4.6
ACS 311-4P1-1	R1	22.4	12.9	10.7	13.0	3	2.2	10.1	4.6

1) Allowed for one minute every ten minutes at 50°C ambient.

2) The impedance of input power supply affects the input current.

3) The single underline () in the type designation stands for "0" or "1".

Chapter 1 - Overview of This Manual

Table 1-2 ACS 300 AC drive types for 50 Hz and 60 Hz supplies.
Input power supply 380 to 480 V.

Type designation ³⁾	Frame	Rated input current ²⁾ 3-phase I_1 [A]	Output current		Maximum permissible rated motor power		Weight	
			Rated current I_N [A]	Short-term overload current I_{OVER} [A] ¹⁾	P_N [Hp]	P_N [kW]	[lbs]	[kg]
ACS 3_1-1P6-3	R1	3.0	2.5	3.8	1	0.75	10.1	4.6
ACS 3_1-2P1-3	R1	3.9	3.2	4.8	1-1/2	1.1	10.1	4.6
ACS 3_1-2P7-3	R1	5.0	4.1	6.2	2	1.5	10.1	4.6
ACS 3_1-4P1-3	R1	7.5	6.2	9.3	3	2.2	10.1	4.6
ACS 3_1-4P9-3	R1	9.1	7.5	11.0	5	3.0	10.1	4.6
ACS 3_1-6P6-3	R1	12.1	10.0	15.0	7-1/2	4.0	10.1	4.6
ACS 3_1-8P7-3	R2	10.6	13.2	19.8	10	5.5	28.7	13.0
ACS 3_1-016-3	R2	21.0	24.0	27.0	15	11.0	28.7	13.0

- 1) Allowed for one minute every ten minutes at 50°C ambient.
 2) The impedance of input power supply affects the input current.
 3) The single underline () in the type designation stands for "0" or "1".

Chapter 1 - Overview of This Manual

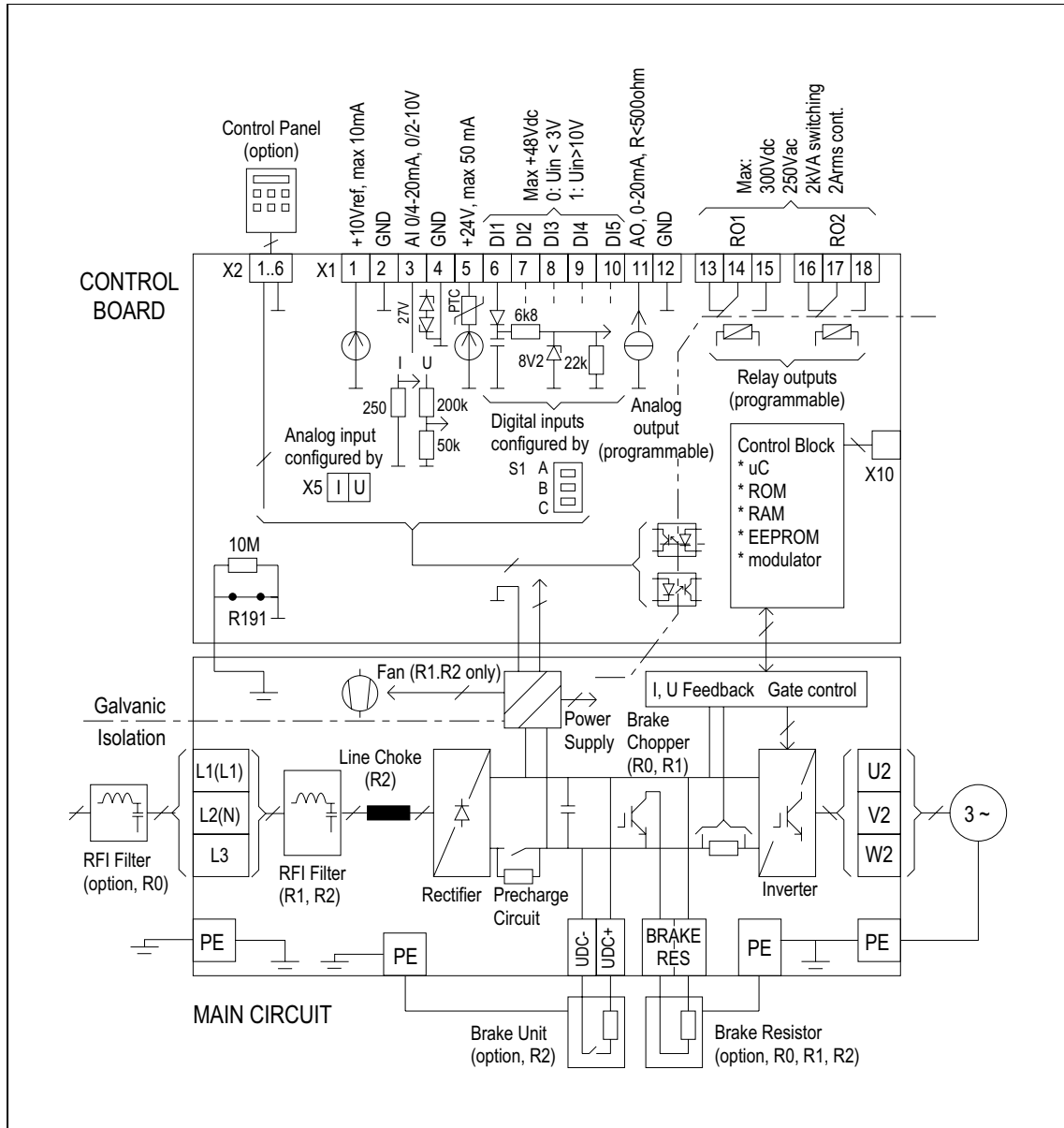

Figure 1-4 ACS 300 block diagram.

Chapter 1 - Overview of This Manual

Chapter 2 - Mechanical Installation

Cooling

Cooling of the ACS 300 is based on natural air circulation or by fan, depending on the type.

The maximum allowable ambient operating temperature is 50°C when the load current is lower than or equal to the continuous maximum load current I_N and switching frequency is lower than or equal to 8 kHz (3 kHz for model ACS 3_1-016-3). See Figure 2-1 below for power derating curves.

The cooling air must be clean and free from corrosive materials. If the cooling air contains dust, clean the cooling surfaces of the unit regularly using compressed air and a brush.

ACS 300 AC drives are to be used in a heated, indoor, controlled environment that is free of moisture and conductive contaminants such as condensation, carbon dust and the like.

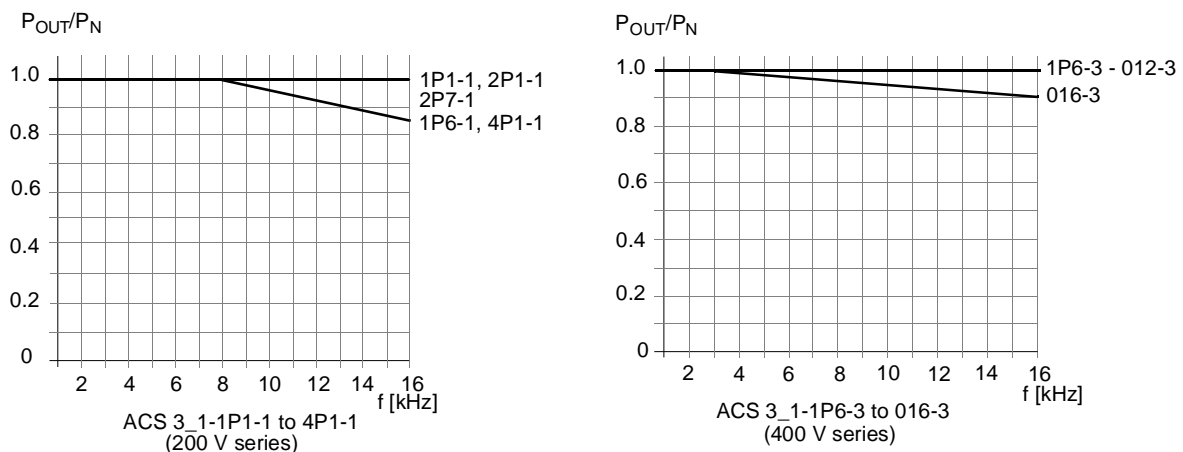

Figure 2-1 Power derating curves by switching frequency.

Chapter 2 - Mechanical Installation

Mounting

Mounting the ACS 300

To ensure proper cooling and safe installation, check that the mounting surface is relatively flat and that there are no openings allowing entrance to the back of the unit. The maximum size of the mounting bolts for ACS 300 units is 1/4" (M6), except for frame size R2 it is #12 (M5).

If multiple units are installed adjacent to or above each other, the following minimum distances apply:

- Units side by side, clearance 1/2 inch (12 mm)
- Units above each other, clearance 12 inches (300 mm)

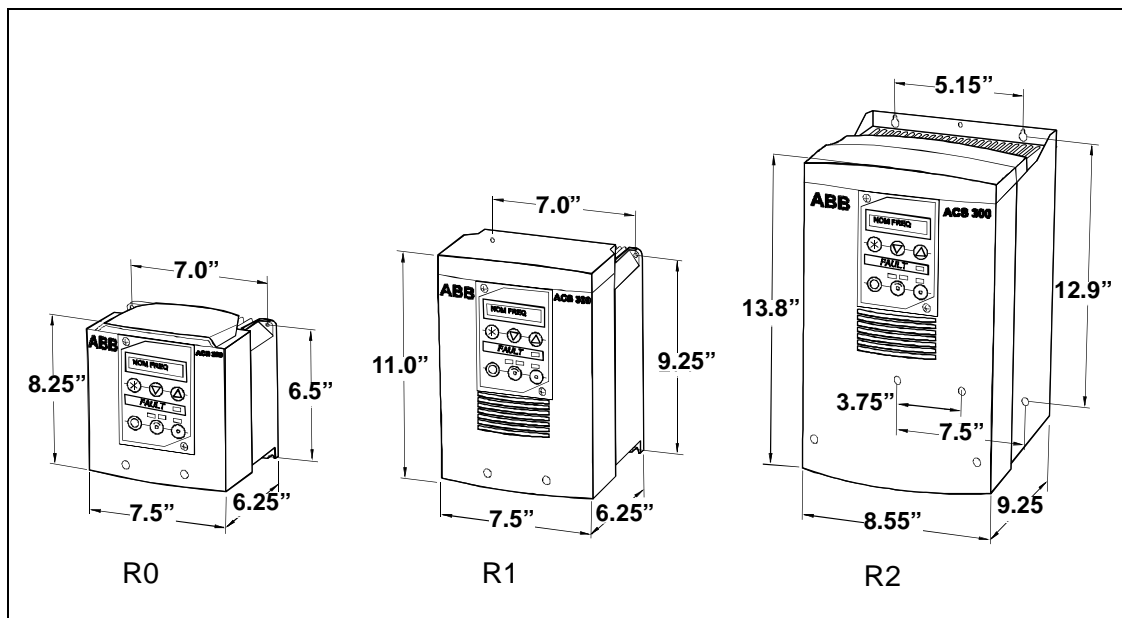

Figure 2-2 ACS 300 Dimensional drawing.

*Chapter 2 - Mechanical Installation****Mounting the Optional Control Panel***

The optional keypad control panel can be mounted to the front of the AC drive by removing the dummy control panel insert from the front of the drive and replacing it with the control panel. The electrical connection is made using a double ended modular phone plug that is about 1.25" long. Insert the latching end of the plug into the jack on the back of the keypad. As the control panel is set in position, insert the other end of the phone plug through the opening in the drive cover into the jack on the front of the drive. Secure the control panel in place using the screws provided.

An optional mounting kit is available for mounting the control panel remotely from the drive. For example, when the drive is mounted inside a larger enclosure, the mounting kit is used to mount the control panel on the enclosure door. The mounting kit includes a cable about 10 feet (3 m) long and a gasket that is suitable for NEMA 4 sealing. Mounting instructions are provided with the kit.

Note! The dummy control panel insert cannot be mounted on the ACS 300 when the Control Panel connection cable is connected.

Note! Use only a connection cable equivalent to the one in the kit. Check the plug polarity. Pin one of the plug at one end of the cable is connected to pin 6 of the plug at the other end. The remainder of the connections are pins 2 to 5 and 3 to 4. If the cable is not correct, the control panel will be damaged.

To minimize radiated RFI emissions, use a metal conduit for the control panel cable if it is not enclosed by a metal enclosure.

Mounting the Optional RFI Filter

The optional RFI filter for frame R0 must be mounted as close as possible to the ACS 300. The metal housing of the filter must be grounded to the drive. If the drive and filter are not mounted in the same enclosure, the filter should be mounted in a small enclosure adjacent to the drive. The wir-

Chapter 2 - Mechanical Installation

ing connecting the filter to the drive must be run in metallic conduit.

Mounting the Drip Shield A drip shield is provided to prevent falling dirt and dripping fluids from entering the ventilation slots at the top of the drive enclosure. The drip shield snaps into place at the top of the enclosure. The enclosure is rated NEMA 1 only when the drip shield is installed.

Chapter 3 - Power Connections

Line Voltage Ratings

The ACS 300 product line includes models for use on 200 to 240 V and models for use on 380 to 480 V supplies. Tables 3-1 and 3-2 list the available models.



WARNING! NEVER connect voltage higher than 240 V to the input power terminals of the 200 to 240 V model ACS 300 drives.

Note! The Factory setting of the 400 V series ACS 300 supply voltage is 480 V. If your voltage is much lower than 480 V, for example 380 V or 400 V, you may get an undervoltage fault message when first using the ACS 300. After connecting the input power, change the value to correspond to the supply voltage. Press the Start/Stop key to reset the fault message.

Power Wiring Requirements

Power wiring includes input power wiring, motor wiring, grounding connections and dynamic braking circuit wiring (optional). Table 3-1 and Table 3-2 provide wire size and input line fuse recommendation. Power wire insulation must be rated 60°C for use in ambient temperatures up to 45°C or 75°C for use in ambient temperatures between 45°C and 50°C.

To gain access to the input power, motor and control terminals, remove the front cover of the unit by loosening the two screws at the bottom. Figure 3-1 shows the locations of the power connection terminals.

Cable clamps that are provided for use with shielded power cables can be removed if shielded power cables are not used. Refer to *Appendix A - Product Conformity in EEA* for information regarding the installation of the ACS 300 in conformance with the requirements of the European Economic Area including recommendations regarding the use of shielded power cables to suppress RFI emissions.

Chapter 3 - Power Connections

Note! To avoid interfering with control signals, route the control wiring away from the power wiring. Avoid long runs of control wiring parallel with power wiring.

Input Power Wiring

The ACS 300 is suitable for use on a circuit capable of delivering not more than 65,000 RMS symmetrical amperes at 240 or 480 volts maximum for the 200 - 240 volt or 380 - 480 volt models respectively.



Caution! The maximum permissible number of DC bus chargings per minute is four. This has to be taken in consideration when using an input power contactor.

Motor Wiring

The ACS 300 provides solid-state motor overload protection. Motor thermal protection is activated using the TEMP LIM parameter. If this feature is not used, the motor connected to the ACS 300 requires overload protection in accordance with the National Electric Code (U.S.A).

The rapid voltage changes cause capacitive current in the motor cable. This current increases with the switching frequency and motor cable length. This phenomenon can cause substantially higher current measured by the ACS 300 than the actual motor current, and can cause over-current tripping. Do not exceed 300 ft. motor cable length. The capacitive current can be reduced by installing an output choke. If the motor cable length exceeds 300 ft., please contact your local distributor or ABB office.

Insulation Checks



Warning! Do not make any voltage tolerance tests (Hi Pot or Meggar) on any part of the ACS 300. Disconnect motor wires from the ACS 300 before making any such tests on the motor or motor wiring. Failure to follow these instructions can result in permanent damage to the ACS 300.

Grounding and Ground Faults



The ACS 300 must always be grounded through an grounding conductor connected to the ground terminal, PE. The grounding conductor should be the same wire size as the input power wires. Metallic conduit is not suitable for use as a grounding conductor.

WARNING! Make sure that the drive is securely grounded before applying power. If the drive is not properly grounded, a dangerous voltage level can develop between the conductive parts of the drive housing and ground due to high leakage current.

The ACS 300 ground fault protection guards only the AC drive itself against ground faults occurring in the motor or the motor wiring. It is NOT designed to protect personnel if they come in contact with the motor wiring.

Ground fault protective devices do not necessarily operate properly with AC drives. Normally occurring high frequency ground leakage currents can cause nuisance tripping. When using such devices, check their performance while the drive is operating during commissioning.

The ACS 300 should be connected only to a grounded power system. If the power system is ungrounded or grounded through a high resistance, please contact ABB for assistance.

Chapter 3 - Power Connections

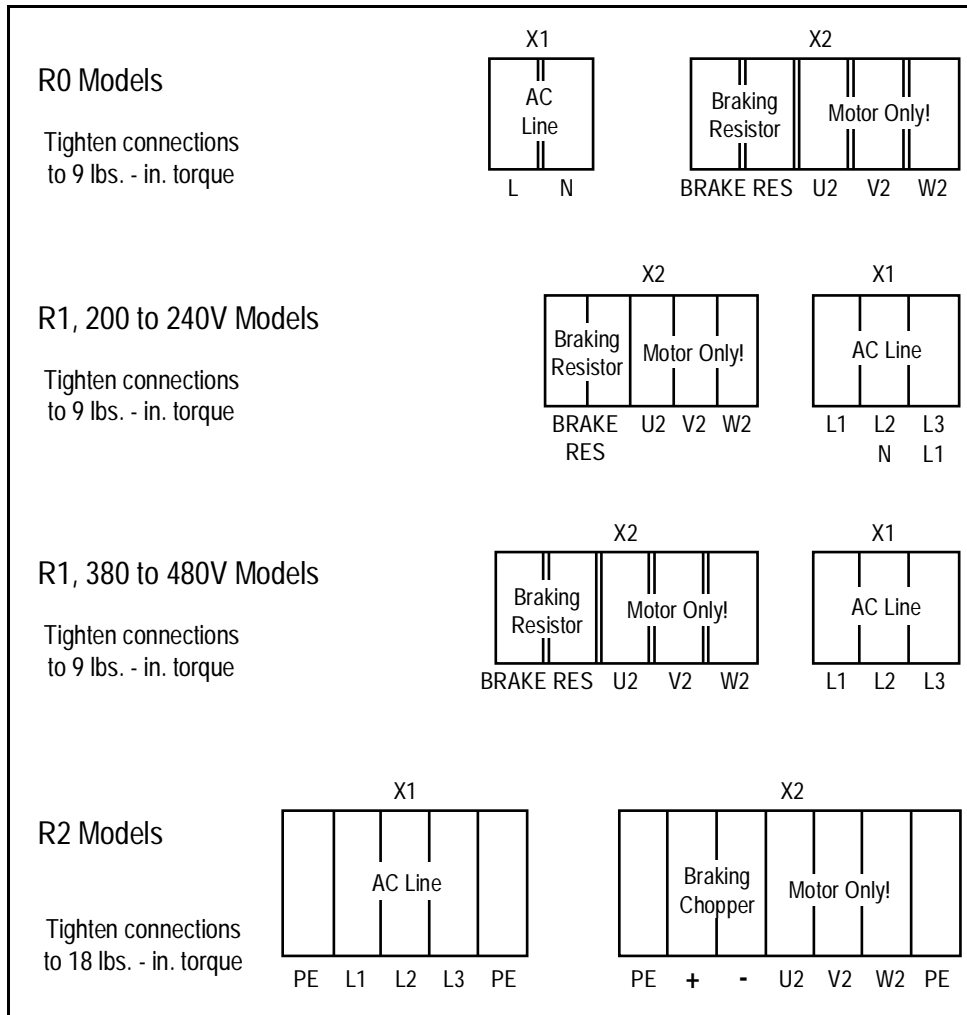

Figure 3-1 Power Connection Terminals

Note: The relative positions of the terminal blocks vary from model to model.

Chapter 3 - Power Connections

Table 3-1 Wire size and fuse recommendations, 200-240 V.

Type designation 208-240 V	Rated input current I_1 [A]		Recommended input fuse [A] Bussman type KTK-R or FWX		Recommended wire size for input power, motor, braking and ground [AWG]	
	1 phase	3 phase	1 phase	3 phase	1-phase	3-phase
ACS 311-1P1-1	6.6	-	10	-	14	14
ACS 311-1P6-1	8.9	-	10	-	14	14
ACS 301-2P1-1	12.2	-	16	10	12	14
ACS 311-2P1-1	12.2	8.4	16	10	12	14
ACS 301-2P7-1	15.7	-	16	10	12	14
ACS 311-2P7-1	15.7	9.8	16	10	12	14
ACS 301-4P1-1	22.4	-	32	16	8	14
ACS 311-4P1-1	22.4	12.9	32	16	8	12

Table 3-2 Wire size and fuse recommendations, 380-480 V.

Type designation 380-480 V	Rated input current I_1 [A]	Recommended input fuse [A] Bussman type KTK-R or FWH	Recommended wire size for input power, motor, braking and ground [AWG]
	3 phase	3 phase	3 phase
ACS 3_1-1P6-3	3.0	10	14
ACS 3_1-2P1-3	3.9	10	14
ACS 3_1-2P7-3	5.0	10	14
ACS 3_1-4P1-3	7.5	16	12
ACS 3_1-4P9-3	9.1	16	12
ACS 3_1-6P6-3	12.1	16	12
ACS 3_1-8P7-3	10.6	16	8
ACS 3_1-012-3	14.4	16	8
ACS 3_1-016-3	21	25	6

Chapter 3 - Power Connections

Chapter 4 - Control Connections

Control Locations The ACS 300 can be controlled by the optional keypad control panel or by external control signals connected to the terminal block X1 of the control card. Serial communication interface is also available.

Control Wiring AWG No. 18 or 20 multiconductor shielded cables should be used for all ACS 300 control wiring. Tighten the connections to 4.5 lbs.-in. torque.

Note! The control connections of the ACS 300 are galvanically isolated from the power circuitry but not from the chassis ground. This is the factory default setting. Control circuit common can be disconnected from chassis ground by cutting the 0 ohm resistor (jumper wire) R191.

Figure 4-1 shows the location of the control terminal block, X1 and the configuration switches and jumpers on the ACS 300 control card.

Figure 4-2 shows the control terminal block connections and summarizes the control terminal functions.

Chapter 4 - Control Connections

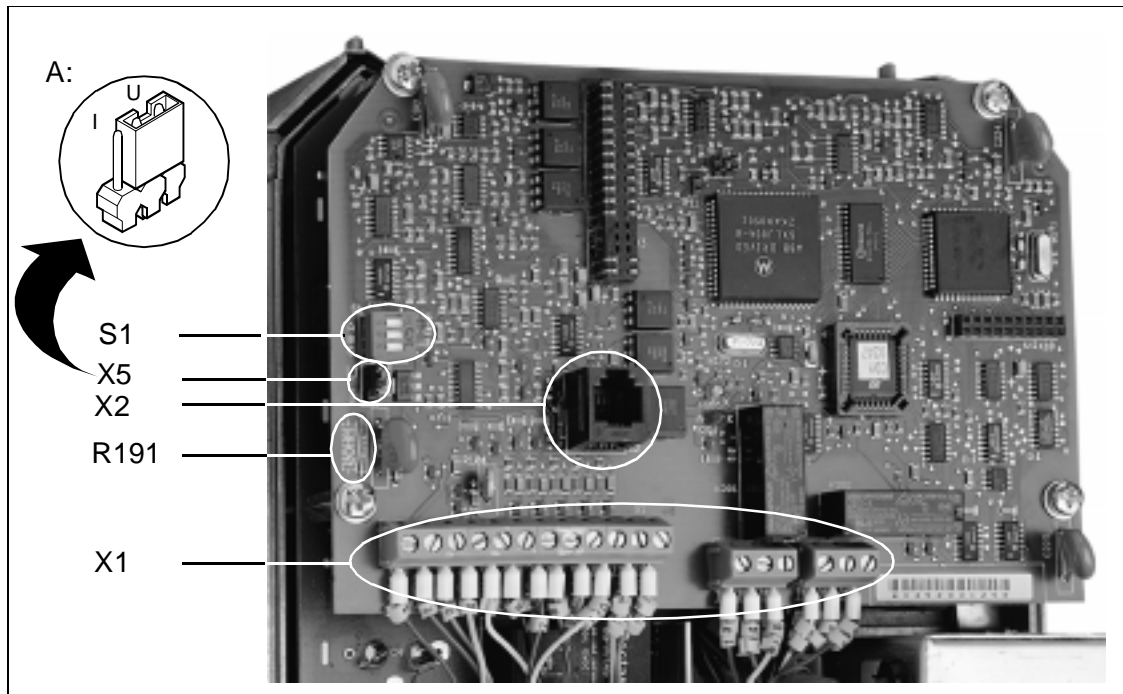

Figure 4-1 Control Card

- Notes for Figure 4-1**
- X1 = Terminal block for control connections.
 - X2 = Plug connection to control panel.
 - X5 = Jumper for selecting analog input signal. See detail A.
I = current 0(4) to 20 mA and *U* = voltage 0(2) to 10 V.
 - S1 = I/O option switch for selecting digital input functions
 DI1 to DI5 and parameter lock.
 - R191 = 0 ohm resistor (jumper wire). Cut to disconnect logic
 common from chassis ground.

Chapter 4 - Control Connections

Figure 4-2 Control Card Connections.

Terminal block X1		Function
1	REF	Reference for potentiometer +10 V DC, maximum permitted burden 10 mA, $1\text{ k}\Omega < R < 10\text{ k}\Omega$
2	GND	
3	AI+	Analogue input, reference 0 to 10 V (or 0 to 20 mA) ¹⁾ or 2 to 10 V (or 4 to 20 mA), $R_i = 200\text{ k}\Omega$ (voltage signal) & $R_i = 250\ \Omega$ (current signal)
4	GND	
5	+24 V	Auxiliary voltage output +24 V DC, max. permitted burden 50 mA
6	DI1	Digital inputs 1- 5 Digital input functions are selected by I/O option switch S1, refer to page 25 for a more detailed description. Control voltage 24 - 48 V
7	DI2	
8	DI3	
9	DI4	
10	DI5	
11	AO+	Analogue output, signal 0 to 20 mA or 4 to 20 mA (minimum selected by Page 2 parameter A. OUT OFFS), $R_L < 500\ \Omega$
12	GND	
13	RO 11	Relay output, programmable (factory setting is Fault). Refer to page 33 for a more detailed description.
14	RO 12	
15	RO 13	
16	RO 21	Relay output, programmable (factory setting is Fault). Refer to page 33 for a more detailed description.
17	RO 22	
18	RO 23	

¹⁾ Refer to Figure 4-1 "Control Card" on page 22 for voltage/current reference selection.

²⁾ Tighten terminal connections to 4.5 lbs.-in. torque.

Parameter Lock

Keypad access to the parameter settings can be locked using section C of I/O option switch S1 on the control card.

If S1, C is in the OFF (0) position, parameter values can be changed and the control location can be switched to local (control panel keypad control).

Chapter 4 - Control Connections

If S1, C is in the ON (1) position, the parameter settings are locked and parameter values cannot be changed, but can be displayed. When locked, control panel keypad control is not allowed and "HARDWARE LOCK S1" message appears on the control panel display if you try to use the panel keys.

Analog Input

The analog input, AI, is used to set the speed reference using an external potentiometer or analog signal. By setting jumper X5, the input can be configured to accept either a voltage signal of 0(2) to 10 V or a current signal of 0(4) to 20 mA. Refer to Figure 4-1. The analog input can scaled and configured for joystick operation using the REF OFFSET parameter as described on page 55. The AI FAULT parameter described on page 64 is used to enable and disable signal loss protection. When the PI controller is activated, the analog input is used only as the actual value (process feedback) input. Refer to the PI GAIN parameter on page 68.

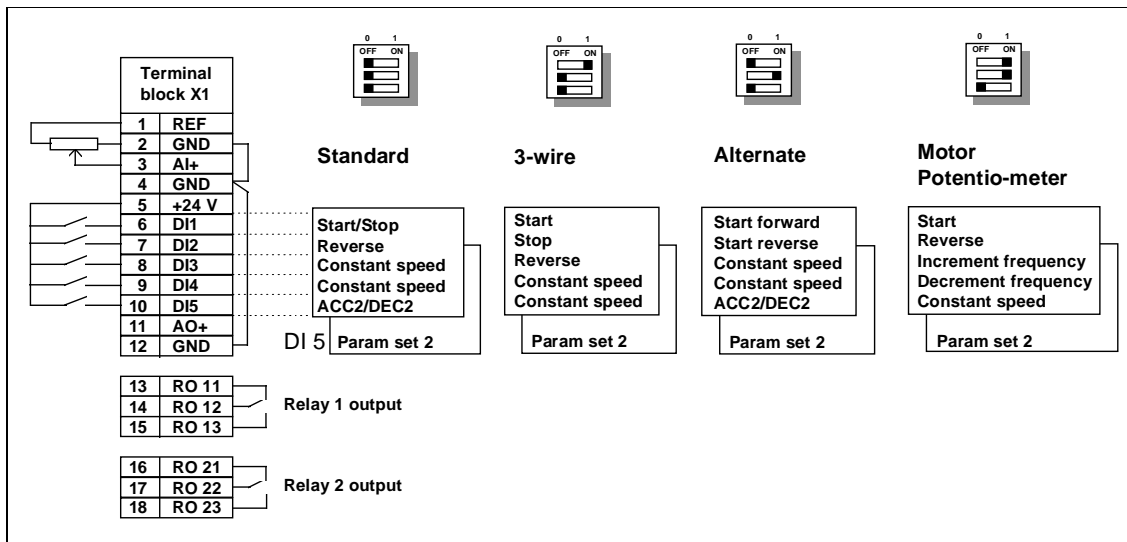

Figure 4-3 Digital Input Configurations

*Chapter 4 - Control Connections***Digital Inputs**

The ACS 300 digital inputs can be configured for eight differently wired control modes. The control modes are configured using the PARAM SET parameter and sections A and B of the I/O option switch, S1 on the control card. The eight configurations are summarized in Figure 4-3. The following list indicates the locations of detailed information covering each configuration.

For PARAM SE = 1, the following configurations can be selected by S1, A and S1, B settings:

- Standard (**Factory Setting**), refer to page 26, Figure 4-4, Table 4-1 and Table 4-2.
- 3-wire, refer to page 27, Figure 4-5, Table 4-5 and Table 4-6.
- Alternate, refer to page 30, Figure 4-6 and Table 4-9 to Table 4-11.
- Motor potentiometer, refer to page 30, Figure 4-7 and Table 4-14.

For PARAM SET = 2, the following configurations can be selected by S1, A and S1, B settings:

- Standard 2, refer to page 27, Figure 4-4, Table 4-3 and Table 4-4.
- 3-wire 2, refer to page 29, Figure 4-5, Table 4-7 and Table 4-8.
- Alternate 2, refer to page 31, Figure 4-6 and Table 4-12 to Table 4-13.
- Motor potentiometer 2, refer to page 33, Figure 4-7 and Table 4-15.

Digital Input Voltage

Digital inputs are activated by closing a switch or relay contact to apply +24 V DC to the input as shown in Figure 4-2 or by applying +24 to +48 V DC from an external source. The following discussion assumes that inputs are activated using

Chapter 4 - Control Connections

the internal 24 V DC supply, but the functions are similar when an external voltage source is used. Where input status is indicated as “0” or “1” in the following tables, “0” designates an open contact or no voltage applied and “1” designates a closed contact or 24 - 48 V DC applied.

Standard The ACS 300 comes from the factory preset to standard. Table 4-1 shows the functions of the digital inputs in standard mode.

Table 4-1 Standard digital input functions.

Digital input	Function	Notes
DI1	Start / Stop	Connect +24 V DC to start
DI2	Reverse	Connect +24 V DC to reverse
DI3	CS	Constant speed (= CS) selection, refer to table 4-2
DI4	CS	
DI5	ACC2/DEC2	0 V = ramp1 and +24 V DC = ramp2

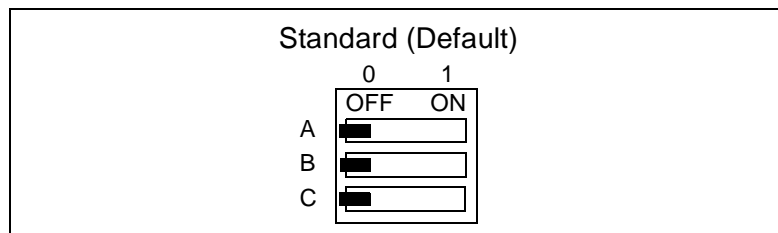

Figure 4-4 Standard switch S1 selection.

Table 4-2 Constant speed selection.

DI3	DI4	Result
0	0	Speed reference from AI1
1	0	Constant speed 1
0	1	Constant speed 2
1	1	Constant speed 3

Chapter 4 - Control Connections

Standard 2 Switch S1 is in the same position as in Standard selection. Parameter PARAM SET has value 2.

Table 4-3 Standard 2 digital input functions.

Digital input	Function	Notes
DI1	Start / Stop	Connect +24 V DC to start
DI2	Reverse	Connect +24 V DC to reverse
DI3	CS	Constant speed (=CS) selection, refer to table 4-4
DI4	CS	
DI5	Parameter set selection	0 V =set 1 and +24 V =set 2

Table 4-4 Standard 2 Constant speed selection

DI3	DI4	DI5	Result
0	0	0	Speed reference from AI1
1	0	0	CS1 (parameter Page 2)
0	1	0	CS2 (parameter Page 2)
1	1	0	CS3 (parameter Page 2)
0	0	1	Speed reference from AI1
1	0	1	CS1 (parameter Page 4)
0	1	1	CS2 (parameter Page 4)
1	1	1	CS3 (parameter Page 4)

3-wire 3-wire is for general industrial applications which usually require a three wire start/stop signal for safety reasons. With 3-wire control, momentary start and stop push-buttons are used. The start button is normally open, and the stop button is normally closed. When operating from external momentary push-buttons, the ACS 300 requires a start command to be given after power is applied.

The stop input is active even when operating from the keypad, allowing the normally closed contact from a motor overload relay or other external interlock to stop the frequency

Chapter 4 - Control Connections

converter when operating from the keypad. Control voltage is connected to X1:7.

Parameter PARAM SET has value 1.

Table 4-5 3-wire digital input functions.

Digital input	Function	Notes
DI1	Start ¹⁾	Connect momentary +24 V DC to Start.
DI2	Stop ²⁾	Connect momentary 0V DC to Stop.
DI3	Reverse	Connect +24 V DC to Reverse.
DI4	CS1	Constant speed (=CS) selection, refer to Table 4-6.
DI5	CS2	

1) Minimum Start pulse is 50 ms. Stop must be connected to +24 V for Start to function.

2) Minimum Stop pulse is 50 ms. If Start is active (+24 V), the ACS 300 will restart after Stop pulse is connected to +24 V

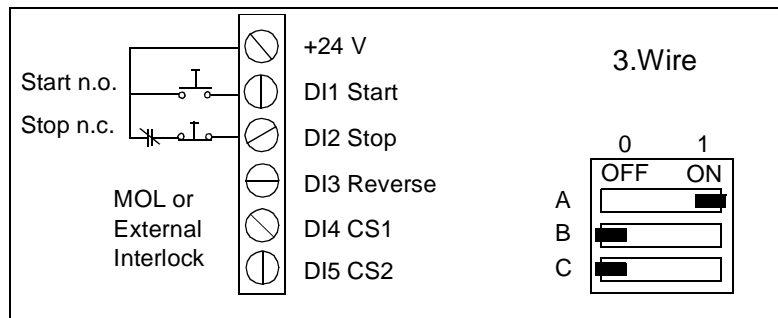

Figure 4-5 3-wire recommended wiring and switch S1 selection.

Chapter 4 - Control Connections

Table 4-6 Constant speed selection.

DI4	DI5	Result
0	0	Speed reference from AI1
1	0	Constant speed 1
0	1	Constant speed 2
1	1	Constant speed 3

3-wire 2 Switch S1 is in the same position as in 3-wire selection. Parameter PARAM SET has value 2.

Table 4-7 3-Wire 2 selection

Digital input	Function	Notes
DI1	Start	Connect momentary +24 V DC to Start.
DI2	Stop	Connect momentary 0V DC to Stop.
DI3	Reverse	Connect +24 V DC to Reverse.
DI4	CS1	Constant speed (=CS) selection, refer toTable 4-8
DI5	Parameter Set Selection	0 V= set 1 and +24 V= set 2

Table 4-8 Constant speed selection

DI4	DI5	Result
0	0	Speed reference from AI1
1	0	CS1 from parameter Page 2
0	1	Speed reference from AI1
1	1	CS1 from parameter Page 4

Chapter 4 - Control Connections

Alternate Alternate mode has both Start forward and Start reverse inputs (+24 V). The drive is stopped if both inputs are connected to 0 V or +24 V. Parameter PARAM SET has value 1.

Table 4-9 Alternate digital input functions.

Digital input	Function	Notes
DI1	Start Forward	Connect +24 V DC to Start Forward/Reverse refer to Table 4-10.
DI2	Start Reverse	
DI3	CS1	Constant speed (=CS) selection, refer to Table 4-11.
DI4	CS2	
DI5	ACC2/DEC2	0 V = ramp 1 and +24 V DC = ramp 2

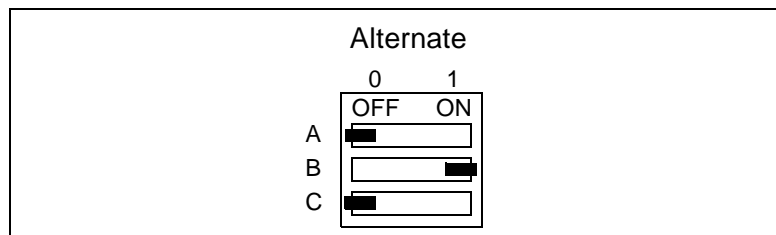

Figure 4-6 Alternate switch S1 selection.

Table 4-10 Start functions for Alternate.

DI1	DI2	Result
0	0	Drive stopped
1	0	Run forward
0	1	Run reverse
1	1	Drive stopped

Chapter 4 - Control Connections

Table 4-11 Constant speed selection.

DI3	DI4	Result
0	0	Speed reference from AI1
1	0	Constant speed 1
0	1	Constant speed 2
1	1	Constant speed 3

Alternate 2 Switch S1 is in the same position as in Alternate selection. Parameter PARAM SET has value 2.

Table 4-12 Alternate 2 digital input functions.

Digital input	Function	Notes
DI1	Start forward	Connect +24 V DC to Start/Reverse, refer to Table 4-10
DI2	Start reverse	
DI3	CS1	Constant speed (=CS) selection, refer to Table 4-13
DI4	CS2	
DI5	Parameter set selection	0 V= set 1 and +24 V= set 2

Table 4-13 Constant speed and parameter set selection.

DI3	DI4	DI5	Result
0	0	0	Speed reference from AI1
1	0	0	CS1 (parameter Page 2)
0	1	0	CS2 (parameter Page 2)
1	1	0	CS3 (parameter Page 2)
0	0	1	Speed reference from AI1
1	0	1	CS1 (parameter Page 4)
0	1	1	CS2 (parameter Page 4)
1	1	1	CS3 (parameter Page 4)

Chapter 4 - Control Connections

Motor Potentiometer Motor Potentiometer mode has motor potentiometer function programmed to digital inputs 3 and 4. Parameter PARAM SET has value 1. Table 4-14 shows the functions of the digital inputs when in Motor Potentiometer mode.

Table 4-14 Motor Potentiometer digital input functions.

Digital input	Function	Notes
DI1	Start	Connect +24 V DC to Start
DI2	Reverse	Connect +24 V DC to Reverse
DI3	Increment fr.	Connect +24 V DC to increment fr. (ramp 2)
DI4	Decrement fr.	Connect +24 V DC to decrement fr. (ramp 2)
DI5	CS1	Connect +24 V DC to select constant speed 1

If you select Start, ACS 300 is set to minimum frequency. If you use Reverse, the drive will continue with a frequency that is the negative value of the valid reference frequency.

The ACS 300 accelerates/decelerates using Page 1 parameters ACC 1/ DEC 1 when changing rotation direction. Acceleration from 0 Hz to MIN FREQ is also done with ramp 1.

Note! AI is disabled when Motor potentiometer control mode is selected.

Note! STOP command (power off) resets parameter REF FREQ.

Chapter 4 - Control Connections

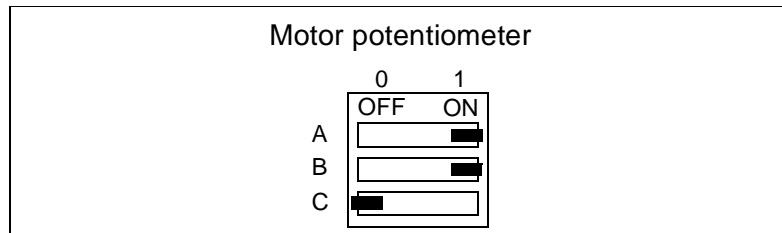

Figure 4-7 Motor Potentiometer switch S1 selection.

Motor Potentiometer 2 Switch S1 is in the same position as in Motor potentiometer selection. Parameter PARAM SET has value 2.

Table 4-15 Motor Potentiometer 2 selection.

Digital input	Function	Notes
DI1	Start	Connect +24 V DC to Start
DI2	Reverse	Connect +24 V DC to reverse
DI3	Increment fr.	Connect +24 V DC to increment fr. (ramp 2)
DI4	Decrement fr.	Connect +24 V DC to decrement fr. (ramp 2)
DI5	Parameter set selection	0 V= set 1 and +24 V= set 2

The ACS 300 accelerates/decelerates using Page 1/ Page 4 parameters ACC 1/ DEC 1 when changing rotation direction. Acceleration from 0 Hz to MIN FREQ is also done with ramp 1.

Relay Outputs

Two relays are provided for indicating drive operating status. Refer to Figure 4-2.

Relay 1 is connected to terminals X1:13, X1:14 and X1:15.
Relay 2 is connected to terminals X1:16, X1:17 and X1:18.

Chapter 4 - Control Connections

When relay 1 is de-energized, there is continuity between terminals X1:13 and X1:14. Relay 1 is de-energized, if the ACS 300 is not connected to input power. When relay 1 is energized, there is continuity between terminals X1:14 and X1:15.

Relay 2 is similar to relay 1 and the corresponding terminals are X1:16, X1:17 and X1:18.

The information indicated with relay outputs can be selected by setting parameters 1. RELAY and 2. RELAY. Refer to Chapter 7 page 64 for further information.

Chapter 5 - Start-up

Flowchart Commissioning Checklist

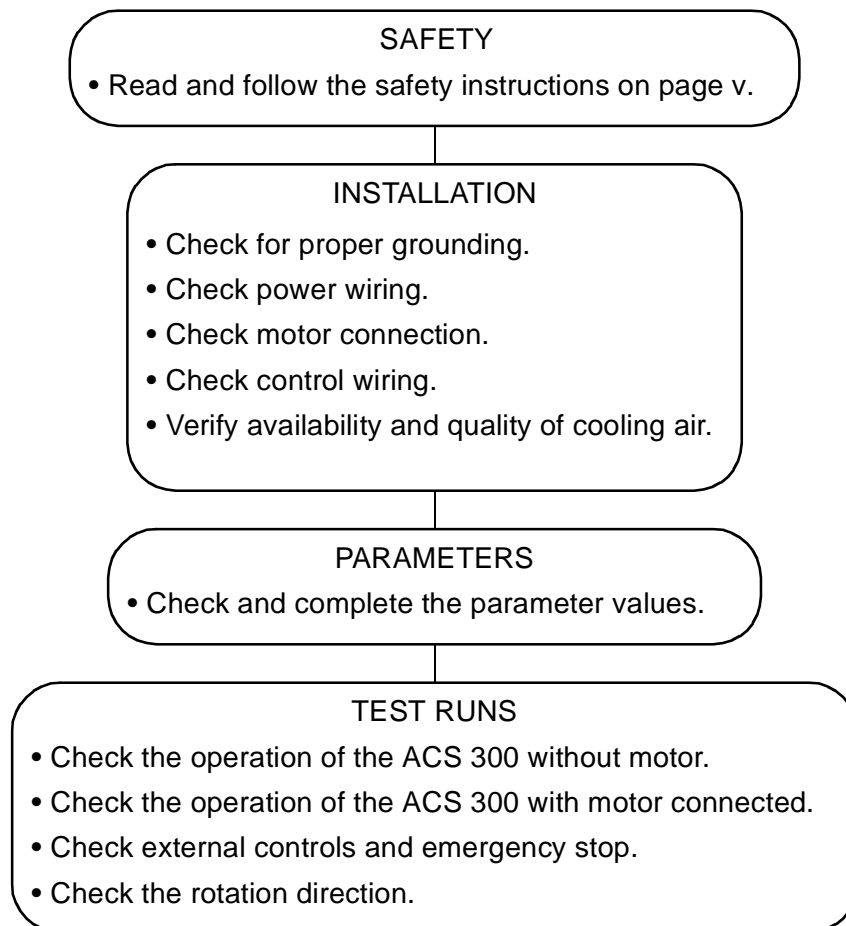

*Chapter 5 - Start-up***Checking the Parameters**

The parameter tables starting on page 45 provide a brief description of each parameter and include a space to write down your customized settings. For each parameter, the table lists the page number on which a detailed explanation of the parameter can be found.



Start-up data Before proceeding with the commissioning, check and complete the following Page 1 and Page 4 parameters which define the motor connected to the ACS 300 and input power supply (400 V series only):

NOM RPM	= Nominal motor speed	Code 113
2NOM RPM	= Nominal motor speed	Code 803
NOM FREQ	= Nominal motor frequency	Code 114
2NOM FREQ	= Nominal motor frequency	Code 804
NOM VOLT	= Nominal motor voltage	Code 115
2NOM VOLT	= Nominal motor voltage	Code 805
COS PHI	= Cos phi of the motor	Code 116
2COS PHI	= Cos phi of the motor	Code 806
SUPPLY VOLT	= Supply voltage (400 V series only)	Code 117

Note! Supply voltage (SUPPLY VOLT) should be set before setting the nominal voltage of the motor (NOM VOLT). Refer to the detailed descriptions of these parameters in Chapter 7 on page 51.

Note! The page 4 settings (2NOM RPM, 2NOM FREQ, 2NOM VOLT and 2COS PHI) should be set to match the corresponding page 1 settings unless special application circumstances require 2 sets of motor characteristic settings.

Chapter 6 - Control and Parameter Logic

- Control Panel** The control panel incorporates a 16 character alphanumeric LCD and keypad. The features are shown in Figure 6-1 on page 38.
- Control panel display** Operational information, parameters and fault indications are displayed in nine languages. Language selections are: English, Finnish, Swedish, German, Italian, French, Spanish, Dutch and Danish. The language selection is made in Page 1 parameter LANGUAGE (refer to chapter 7, on page 45).
- Display contrast** To adjust the display contrast, hold  down and press  for darker or  for lighter contrast.

Chapter 6 - Control and Parameter Logic

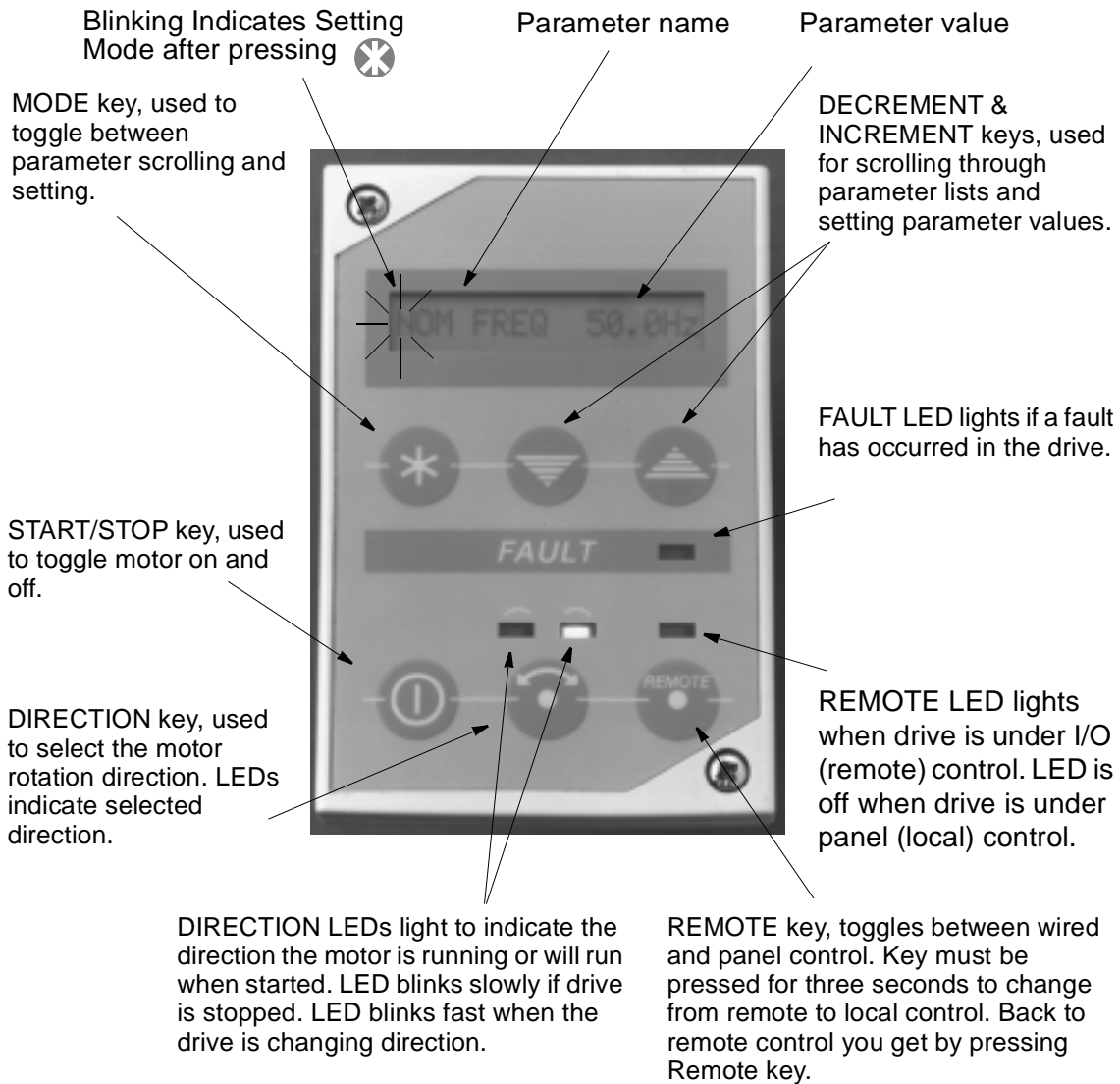





Figure 6-1 ACS 300 Control Panel.

*Chapter 6 - Control and Parameter Logic***Panel Operation**

The ACS 300 frequency converter can be operated from external controls or directly from the control panel. The panel is an option. The first time the ACS 300 is connected to input power, the default control location is Remote. You can change the control location to Local (panel control) by pressing and holding the  key down for three seconds. The associated LED will turn off indicating that the ACS 300 is not under remote control.

Remote When the  key is pressed, the associated led will turn on indicating that the ACS 300 is under remote control. The ACS 300 is then controlled from the devices connected to the terminal block X1 on the Control Card.

Local Operation can be changed from Remote to Local in two ways. The first method allows you to transfer running information from external devices to the control panel while the ACS 300 is operating and without interrupting operation.

Press and hold the  key and the  key simultaneously for three seconds. This will transfer the current external reference to Page 1 parameter REF FREQ/LOC FREQ. For example, if the drive is running in reverse at 45.7 Hz reference from the analog input, the panel frequency reference will now be 45.7 Hz. The panel direction will be reverse and the panel run status will be run. The operator can now change the frequency, direction and run status of the drive from the control panel.

If only the  key is pressed, the motor stops and the analog input reference value REF FREQ is transferred to LOC FREQ. **Note!** Constant speed reference is also transferred. The motor can be started from the control panel within the limits established by parameter settings.

Chapter 6 - Control and Parameter Logic



















Home Press and hold the  key and the  key simultaneously for three seconds to move to the OUTPUT f parameter from any parameter location.

Table 6-1 Control panel keys.

Control Panel Key	Secondary Key	Function
		Press to change between Display mode and Setting mode.
	 	Hold down to set the display contrast and: Press to adjust contrast darker or Press to adjust contrast lighter.
		Press and hold for three seconds to change between remote control and local control. Refer to "Panel Operation" on page 39 for an explanation. Note! Hardware panel lock prevents local control. Message if key is pressed: "HARDWARE LOCK S1".
		Hold down for 3 seconds to select the Local control mode: Transfers the running data to local control (current speed/direction/start).
		Press to start or stop the drive or Press to reset an active fault. (Fault is active when the fault LED is illuminated.)
		Press to set motor rotation direction. Note! This procedure reverses the motor only when the drive is running in Local control mode. Refer to "Local" on page 39 for additional information.

Chapter 6 - Control and Parameter Logic

Control Panel Key	Secondary Key	Function
		Hold down to scroll up in Display and Setting modes.
		Hold down to scroll down in Display and Setting modes.
		Press to change up to the next parameter in Display mode or Press to increment the current parameter value in Setting mode.
		Press to change <i>down</i> to the next parameter in Display mode or Press to decrement the current parameter value in Setting mode.
		Press and hold both keys simultaneously for three seconds to move directly to the OUTPUT f parameter.
LED's 		Remote light indicates the ACS 300 is under remote control. When the remote light blinks slowly, an option is selected as the master device.
		Direction light indicates the current motor rotation direction. When the direction light flashes slowly, the ACS 300 is in Stop status. When the direction light flashes fast, the ACS 300 is changing rotational direction.

Chapter 6 - Control and Parameter Logic

Parameter Logic

The parameters are divided into four pages. A complete table of parameters is presented in chapter 7 on page 45

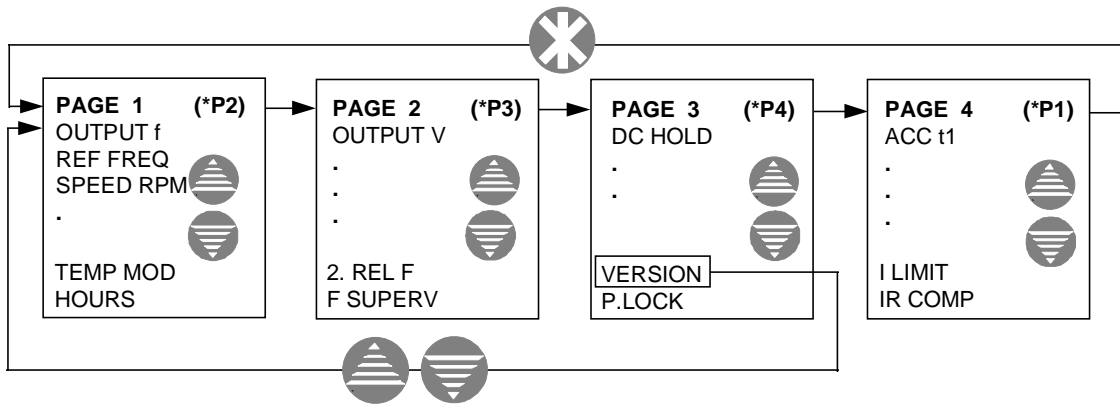

Figure 6-2 Menu system of parameters.

Chapter 6 - Control and Parameter Logic

Example

Let us suppose that you want to set Page 2 parameter CONf1 to 15 Hz. The following example explains the procedure required starting from the Page 1 parameter SPEED.

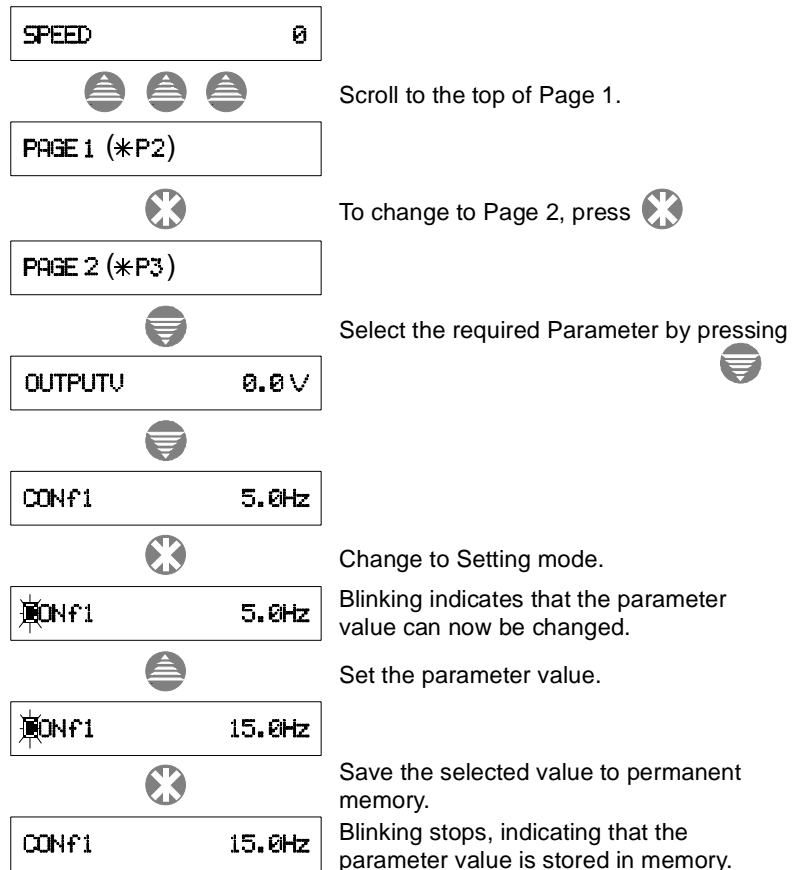



Figure 6-3 Example of Control Panel operation.

Note! To accelerate the rate of change of parameter value, press and hold the  or  key.

Chapter 6 - Control and Parameter Logic

Chapter 7 - Drive Parameters

Parameter Tables

The following parameter tables list the drive parameters, adjustment ranges and default values. A space is provided for recording customer settings. The tables include a short description of each parameter and lists the page numbers where a detailed explanation can be found.

Note! The factory setting for display language is English, refer to Page 1 parameter LANGUAGE for display language selection. Parameters marked with (0) can only be altered with the ACS 300 stopped otherwise START IS ACTIVE message is displayed. (L) indicates that the parameter can be altered in Local control mode only.

Table 7-1 Page 1 Drive parameters and their factory settings.

Code	Parameter	Range	Default	Customer	Page	Description
	PAGE 1 (*P2)	Display only	-	-	48	Press  to change to page 2
101	OUTPUT f	Display only	-	-	48	Frequency to motor
102	REF FREQ/ LOC FREQ (L)	$f_{MIN} - f_{MAX}$	0 Hz		49	Frequency reference from remote or control panel
103	SPEED	Display only	-	-	49	Calculated motor speed
104	OUTPUT I	Display only	-	-	49	Motor current
105	COPY	Exit/Read/Write/ Set Factory Def.	Exit	-	49	Transfers all settings to and from panel
106	MIN FREQ	0.0 – 200/500 Hz ¹⁾	0.0 Hz		49	Reference input minimum frequency
107	MAX FREQ	0.0 – 200/500 Hz ¹⁾	50 Hz		49	Maximum output frequency
108	ACC 1	0.1 – 1800 s ²⁾	3 s		49	Time for Ref Min f - Ref Max f acceleration ramp
109	DEC 1	0.1 – 1800 s ²⁾	3 s		49	Time for Ref Max f - Ref Min f deceleration ramp
110	ACC 2	0.1 – 1800 s ²⁾	3 s		49	Time for Ref Min f - Ref Max f acceleration ramp
111	DEC 2	0.1 – 1800 s ²⁾	3 s		49	Time for Ref Max f - Ref Min f deceleration ramp

Chapter 7 - Drive Parameters

Code	Parameter	Range	Default	Customer	Page	Description
112	FAULT MEMORY	Display only	-		50	The last three fault indications
113	NOM RPM (0)	0 – 19999	1500		50	Nominal motor speed
114	NOM FREQ (0)	50 – 400 Hz	50 Hz		51	Nominal motor frequency
115	NOM VOLT (0)	200 – 240V or 360 - 500 V ³⁾	220V or 480 V ³⁾		51	Nominal motor voltage
116	COS PHI (0)	0.40 – 0.99	0.75		51	Motor power factor
117	SUPPLY VOLT ³⁾ (0)	380 to 480 V	480 V		51	Supply voltage selection
118	LANGUAGE	GB,SF,S,D,I,F, E,NL,DK	English		51	Display language selection
119	TEMP MOD	Display only	-		51	Calculated motor temperature
120	HOURS	Display only	-		51	Operation timer

¹⁾ Depends on the selected nominal motor frequency (Page 1 parameter NOM FREQ)

²⁾ **Note!** The maximum value for ACC/DEC time is going to be lower than 1800 s, when the absolute value of MIN FREQ – MAX FREQ is <100Hz.

³⁾ Only 400 V series

Table 7-2 Page 2 Drive parameters and their factory settings.

Code	Parameter	Range	Default	Customer	Page	Description
	PAGE 2 (* P3)	Display only	-	-	51	Press  to change to page 3
201	OUTPUT V	Display only	-	-	52	Output voltage to motor
202	CON f 1	0.0 – 200/500 Hz ¹⁾	5.0 Hz		52	Preset speed 1
203	CON f 2	0.0 – 200/500 Hz ¹⁾	25.0 Hz		52	Preset speed 2
204	CON f 3	0.0 – 200/500 Hz ¹⁾	50.0 Hz		52	Preset speed 3
205	I LIMIT	0.5 – 1.5 x I _N	1.5 x I _N		52	Output current limit
206	START (0)	Acc Ramp/Flying/Auto Boost/ Fly+Boost	Acc Ramp		52	Starting mode selection
207	STOP (0)	Coasting/Dec Ramp/ DC Brake/Dec+Brake/ Dec+Hold	Coasting		53	Stopping mode selection
208	RAMP (0)	Linear/Fast S/ Medium S/Slow S	Linear		54	Acceleration/deceleration ramp shape selection
209	REF OFFSET (0)	0V 0mA/2V 4mA/ Joystk/Custom	0 V 0 mA		55	Analog input minimum and type selection

Chapter 7 - Drive Parameters

Code	Parameter	Range	Default	Customer	Page	Description
210	A. OUT	None/Out Freq/Ref Freq/Motor Curr	None		57	Analog output function selection
211	A. OUT OFFS	0 mA/4 mA	0 mA		57	Analog output minimum
212	SWITCH f	1.0 – 16.0 kHz	4 kHz		58	Switching frequency
213	CRIT f1L	0.0 – 200/500 Hz ¹⁾	0.0 Hz		58	Critical frequency 1 start
214	CRIT f1H	0.0 – 200/500 Hz ¹⁾	0.0 Hz		58	Critical frequency 1 end
215	CRIT f2L	0.0 – 200/500 Hz ¹⁾	0.0 Hz		58	Critical frequency 2 start
216	CRIT f2H	0.0 – 200/500 Hz ¹⁾	0.0 Hz		58	Critical frequency 2 end
217	IR-COMP	Off/0.1 – 60 V/ Auto	Off		60	Low speed torque boost value
218	DC BRAKE	0 – 250 s	3 s		61	Duration of DC braking/DCHold
219	U/f RATIO (0)	Linear/Square/Optim	Linear		61	Voltage to frequency ratio
220	RESTART #	Off/1 - 10/Cont	Linear		62	Nr. of start attempts after fault
221	TEMP LIM	Off/1 to 500 Hz	Off		62	Motor Thermal Protection
222	Motor I	0.5 to 1.5* I _N	I _N		63	I _{NMOT} for thermal protection
223	DIR	FWD/REV: FWD only	FEW?REV		64	Reverse lock-out
224	AI-FAULT	Enable/Disable	Enable		64	AI fault if AI < 2 V/ 4mA
225	1. RELAY	1 - 11	1		64	Relay 1 function selection
226	2. RELAY	1 - 11	7		64	Relay 2 function selection
227	F SUPERV	0.0 to 500 Hz			66	Relay function output freq. limit

Table 7-3 Page 3 Drive parameters and their factory settings.

Code	Parameter	Range	Default	Customer	Page	Description
	Page 3 (*P4)	-	-	-	66	Press  to change to page 4
701	DC HOLD	0/ 1/ 2	0		66	None/ Normal/ Strong DC hold
702	PARAM SET	1/ 2	1		67	Enables/disables extended I/O configuration/ Parameter set 2
703	PI-GAIN (0)	0 - 800 %	0		68	PI-Controller Gain selection
704	PI-ITIME	0.0 - 320.0 s	0		68	PI-Controller I-time selection
705	PI-SCMIN	-999.9 - 999.9%	0		69	Minimum scaling factor of Actual value
706	PI-SCMAX	-999.9 - 999.9%	100		69	Maximum scaling factor of Actual value

Chapter 7 - Drive Parameters

Code	Parameter	Range	Default	Customer	Page	Description
707	PI-REF(L)	0.0 - 100.0	0		70	PI-Controller Reference value
717	VERSION	Display only			71	Displays program version
718	P. LOCK	Open/ Locked	Open		71	

Table 7-4 Page 4 Drive parameters and their factory settings.

Code	Parameter	Range	Default	Customer	Page	Description
	PAGE 4 (*P1)	-	-	-	71	Press  to change to page 1
801	2ACC 1	0.1 - 1800 s	3		49	Parameter set 2 parameters are similar to the parameters in pages 1 and 2.
802	2DEC 1	0.1 - 1800 s	3		49	
803	2NOM RPM (0)	0 - 19999	1500		50	
804	2NOM FREQ (0)	50 - 400 Hz	50		51	
805	2NOM VOLT (0)	200 - 240 V or 360 - 480 V	220/480V		51	
806	2COS PHI (0)	0.40 - 0.90	0.75		51	
807	2CON f 1	0.0-200/500Hz	5		52	
808	2CON f 2	0.0-200/500Hz	25		52	
809	2CON f 3	0.0-200/500Hz	50		52	
810	2I LIMIT	0.5 - 1.5 x I _N	1.5*I _N		52	
811	2IR-COMP	Off/0.1 - 60 V/ Auto	Off		60	

Detailed Parameter Information

The remainder of this chapter is devoted to detailed explanations of each parameter.

Page 1 parameters

PAGE 1 (*P2) Press  to change to Page 2.

OUTPUT f Frequency to motor. This parameter is display only. Jump directly to local frequency reference setting, parameter LOC FREQ, by pressing .

Chapter 7 - Drive Parameters

REF FREQ/ The frequency reference input or local frequency reference.
LOC FREQ

SPEED Motor speed in RPM. The indicated value is valid only if parameter NOM RPM has been set correctly. The motor speed slip is not compensated. Information is updated four times per second.

OUTPUT I Calculated motor phase current. Accuracy $\pm 10\%$. Includes cable losses.

Note! This display is not for accurate measurement.

COPY Copy is used to transfer all parameter settings from one ACS 300 to another.

EXIT

Copy function not selected.

READ

Reads all parameter values from the ACS 300 to the control panel memory.

WRITE

Copies all parameter values from the control panel memory to the ACS 300.

SET FACTORY DEF

If you select **SET FACTORY DEF** and press the  key, all the parameters will be reset to the factory settings.

MIN FREQ Reference input minimum and maximum frequency.

MAX FREQ **Note!** MIN can be set higher than MAX for analog input signal inverse operation.

ACC TIME 1 These times correspond to the time required for the output
DEC TIME 1 frequency to change from MIN FREQ to MAX FREQ and
ACC TIME 2 vice versa. Regardless of the settings, the maximum theo-
DEC TIME 2 retical frequency changing speed is 120 Hz/0.1 s and the
 minimum

Chapter 7 - Drive Parameters

100 Hz/1800 s. The time required for acceleration from zero to minimum frequency depends on ACC 1.

When the selected I/O mode is Standard or Alternate, DI5 selects ACC/DEC 1 or 2. 0 V = ramp 1 and +24 V = ramp 2. Refer to page 25 for a detailed explanation of I/O modes.

Note! The ACS 300 incorporates a controller that prevents over current and overvoltage trips caused by too rapid acceleration and deceleration settings for a given system, by slowing down the acceleration/deceleration.

If a short time is entered for acceleration time in a system with high inertia, the acceleration time will be limited by the LIMIT parameter. Conversely, if a short time is entered for deceleration time in such a system, the deceleration time will be limited by the DC link bus regulator. In some cases, the motor will take a long time to come to a stop. If the system inertia is high, an OVERVOLTAGE fault may occur if the deceleration time is too short. The ACS 300 can deliver about 15 % braking torque without an external braking resistor. If a short deceleration time is critical to your system, we suggest you add a dynamic braking resistor to your system. Brake Resistor is available as an option for all frame sizes. Chopper is available as an option for frame size R2.

If the reference signal changes at a slower rate than the acceleration or deceleration time, the output frequency change will follow the reference signal. If the reference signal changes faster than the acceleration or deceleration time, the output frequency change will be limited by the parameters.

FAULT MEMORY The ACS 300 continuously monitors itself for faulty operation. The last three faults are stored on Page 1 parameter FAULT MEMORY. Refer to “Chapter 8 - Fault Tracing” on page 71, for further information on fault memory.

NOM RPM Nominal motor rpm from the motor rating plate.

Chapter 7 - Drive Parameters

NOM FREQ Nominal motor frequency from the motor rating plate (sometimes called the field weakening point). The maximum output frequency of the ACS 300 is determined according to the nominal motor frequency:

50-100 Hz => $f_{\max} = 200$ Hz; 101-400 Hz => $f_{\max} = 500$ Hz

NOM VOLT Nominal motor voltage (from the motor rating plate). NOM VOLT sets the maximum output voltage supplied to the motor by the ACS 300. NOM FREQ sets the frequency where the voltage to the motor is equal to NOM VOLT. With these two parameters, it is possible to adapt the ACS 300 to the motor.

The ACS 300 cannot supply the motor with a voltage greater than the incoming line voltage. When driving a motor that has a nominal voltage lower than the supply voltage, it may not be possible to drive the motor at full torque because of current limitations.

COS PHI Power factor (Cos phi) of the motor from the motor rating plate.

SUPPLY VOLT Incoming power line supply voltage. This parameter exists only in the 400 series units.
Note! NOM VOLT can only be set within ± 20 V of SUPPLY VOLT.

LANGUAGE Select the preferred display language.

TEMP MOD Calculated temperature of the motor as a percentage (%) of nominal temperature. Motor temperature is calculated from the motor current. MOTOR TEMP fault occurs when TEMP MOD signal is equal to 115 %.

HOURS Operation timer shows in hours how long the drive has been running.

Page 2 parameters

PAGE 2 (*P3) Press  to change to Page 3.

Chapter 7 - Drive Parameters

OUTPUT V The voltage applied to the motor. This parameter is display only.

CON f1 Constant frequency (preset speed) 1, 2 and/or 3. Constant
CON f2 frequencies override the analog input reference. Constant
CON f3 frequencies are activated with Digital Inputs 3 and 4 or Digital Inputs 4 and 5 depending on the control mode selected. For constant frequency selection, refer to I/O mode descriptions on pages 26 to 31.

Note! Min and Max Freq parameters are ignored when constant speed is used.

I LIMIT This setting is the maximum output current the ACS 300 will supply to the motor.

START(FUNCTION) ACC RAMP

Ramp acceleration as set on Page 1 / Page 4 parameter ACC 1 (or ACC 2 as selected by digital inputs in Standard and Alternate I/O mode, refer to page 26 and page 30).

FLYING

Use this setting to start the motor if it is already rotating, as in a fan drive. The drive will start smoothly at the current frequency instead of starting at 0 Hz. By selecting **FLYING**, the drive will be able to ride through short interruptions of the AC line supply.

Note! Flying start searches for the running speed by applying a small torque to the load at the maximum frequency and decreasing the output frequency until the load speed is found. If the motor is not coupled to a load or the load has low inertia, the motor will start at a speed higher than the set reference.

Note! If the motor and load are rotating in a direction opposite to the commanded rotation, the ACS 300 will start the motor from 0 Hz and accelerate according to the selected acceleration ramp.

*Chapter 7 - Drive Parameters***AUTO BOOST**

Automatic start current boost, which may be necessary in drives with high starting torque. Automatic torque boost is active only from 0 Hz to 20 Hz or until the reference speed is reached. Torque boost is not activated if the output frequency falls below 20 Hz while running. See also Page 2 parameter IR COMP.

FLY+BOOST

Activates both the Flying Start and Automatic Start Current Boost.

STOP (FUNCTION) **COASTING**

The ACS 300 stops supplying voltage when a Stop command is given and the motor coasts to a stop.

DEC RAMP

Ramp deceleration as set in Page 1 / Page 4 parameter DEC 1 (or DEC 2) as selected by digital inputs in Standard and Alternate I/O mode, refer to page 26 and page 30.

DC BRAKE

DC injection braking stops the motor by applying DC voltage to the stator windings. By using DC braking, the motor can be stopped in the shortest time possible, without using a dynamic braking resistor.

DEC+BRAKE

This should be used only when a Braking Resistor (and with frame size R2+Braking Chopper) is connected in order to get the best result.

DEC+HOLD

Ramp deceleration as set in Page 1 / Page 4. After ramp DC HOLD is set on for a period defined by parameter DC BRAKE. Parameter DC HOLD defines the intensity of the DC HOLD.

Chapter 7 - Drive Parameters

RAMP This parameter allows you to select the shape of the acceleration/deceleration ramp as shown in Figure 7-1. The available options are:

LINEAR

Suitable for drives requiring steady acceleration/deceleration.

FAST S

Suitable for ramp times less than one second.

MEDIUM S

Suitable for ramp times less than 1.5 seconds.

SLOW S

Suitable for ramp times up to 15 seconds.

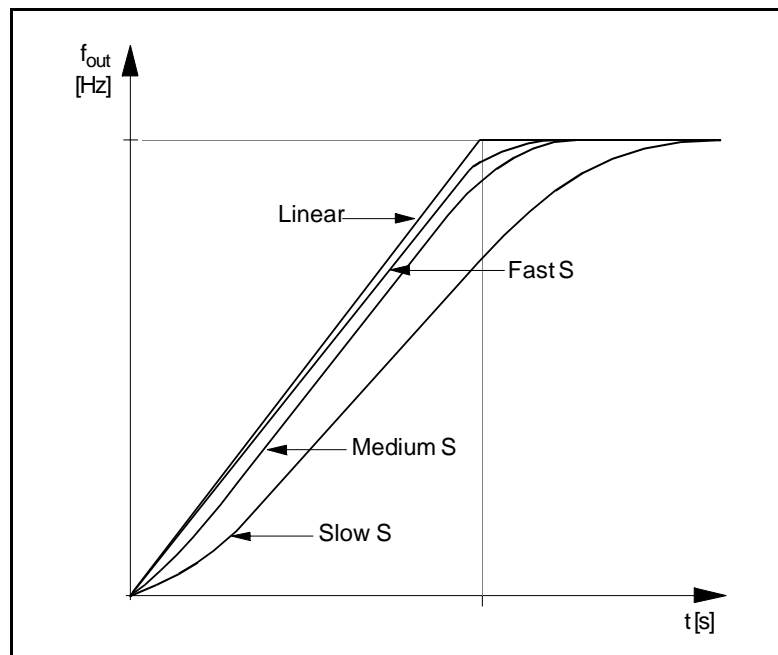

Figure 7-1 Acceleration/deceleration ramp shapes.

*Chapter 7 - Drive Parameters***REF OFFSET 0 V/0 mA**
2 V/4 mA

Reference input signal minimum level can be set to either 0 V / 0 mA or 2 V / 4 mA. The latter value provides a “living zero” function. The drive will stop if the reference drops below the minimum limit. Refer to Figure 4-1 on page 22 for selection between current and voltage input.

JOYSTK 0V0mA**JOYSTK 2V4mA**

Joystick type reference has 0 Hz at 50% reference. Refer to Figure 7-2, below.



WARNING! If a 0-10 V (0-20 mA) signal is used in joystick control, the drive will run at **MAX_FREQ Reverse** if the control signal is lost. For joystick control, we recommend that you use **JOYSTK 2 V/4 mA** offset which will cause the drive to stop if parameter **AI-FAULT** has been enabled (refer to page 64) and the control signal is lost.

Chapter 7 - Drive Parameters

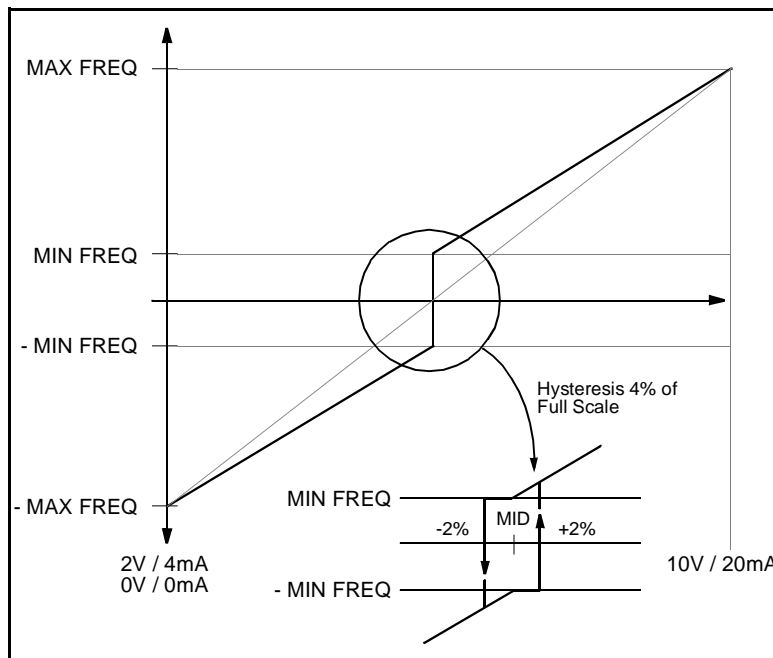

Figure 7-2 Joystick control.

CUSTOM

Use this setting if you want to set and use customized minimum and maximum limits for the reference input. The customized limits are valid when `CUSTOM` is selected.

To set the limits, refer to selections `SET MIN` and `SET MAX` below.

SET MIN (displayed in % of the full input signal range)

SET MAX (displayed in % of the full input signal range)

Sets the minimum/maximum limit for the reference input signal. To set the minimum reference signal level, scroll to `SET MIN` and apply the analog input signal that represents minimum frequency in your system. Press and hold the  key for three seconds. The setting is accepted when * blinks once on the Control Panel display. To set the maximum ref-

Chapter 7 - Drive Parameters

reference signal level, scroll to **SET MAX** and repeat the procedure as for **SET MIN**.

Note! The drive will stop, a fault message “LOW AI-SIGNAL” appears and the fault LED lights if parameter **AI-FAULT** (refer to page 64) has been enabled and the reference drops below the selected minimum limit.

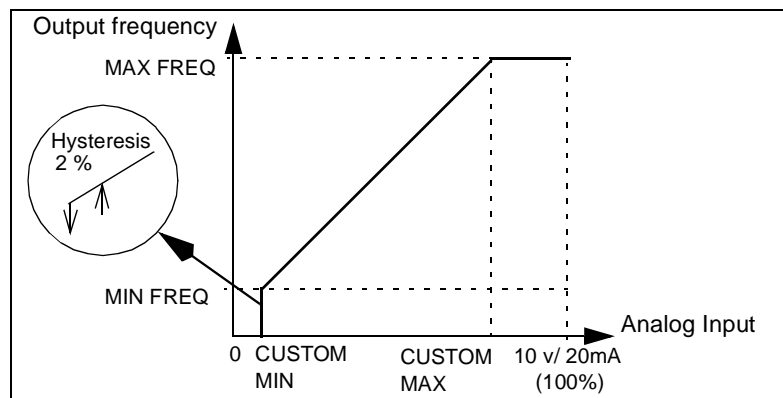

Figure 7-3 Customized minimum and maximum limits for the reference input.

- A. **OUT** This parameter selects which signal is connected to analog output.
- NONE** – Analog output is 0 mA.
 - OUT FREQ** – Output frequency
(0 to the selected maximum frequency)
 - REF FREQ** – Reference frequency
(0 to the selected maximum frequency)
 - MOTOR CUR** – Motor current
(0 to 1.5 x I_N , see Table 1-1 and Table 1-2)
- A. **OUT OFFS** The analog output signal minimum can be set to 0 mA or 4 mA. The maximum output remains 20 mA. Selecting 4 mA provides a “living zero” function. If a fault occurs, the output current will drop to 0 mA as an alternate fault indicator signal.

Chapter 7 - Drive Parameters

SWITCH f Motor noise can be minimized by adjusting the switching frequency to a value that does not create resonances in the motor system. The optimum switching frequency is the lowest frequency at which the noise is acceptable. This frequency may not be the same for identical motor systems. As the switching frequency goes up, the inverter efficiency goes down, so it is best to use a low switching frequency if the application can tolerate noise.

Note! At output frequencies less than 12 Hz, the switching frequency may be automatically reduced.

CRIT f1L
(CRIT f1H)
(CRIT f2L)
(CRIT f2H) In some systems it may be necessary to avoid certain frequencies because of mechanical resonance problems. With these parameters it is possible to set up two different frequency ranges that the ACS 300 will skip over. It is not necessary that, for example, CRIT f2L be greater than CRIT f1H, just as long as the LOW parameter in one set is lower than the HIGH parameter in the same set. Sets may overlap, but the skip will be from the lower LOW value to the higher HIGH value.

Example: Fan system with bad vibration from 18 Hz to 23 Hz and from 46 Hz to 52 Hz. Running speed set to 60 Hz with reference. Set the parameters as follows:

CRIT f1L = 18 Hz and CRIT f1H = 23 Hz
CRIT f2L = 46 Hz and CRIT f2H = 52 Hz

Chapter 7 - Drive Parameters

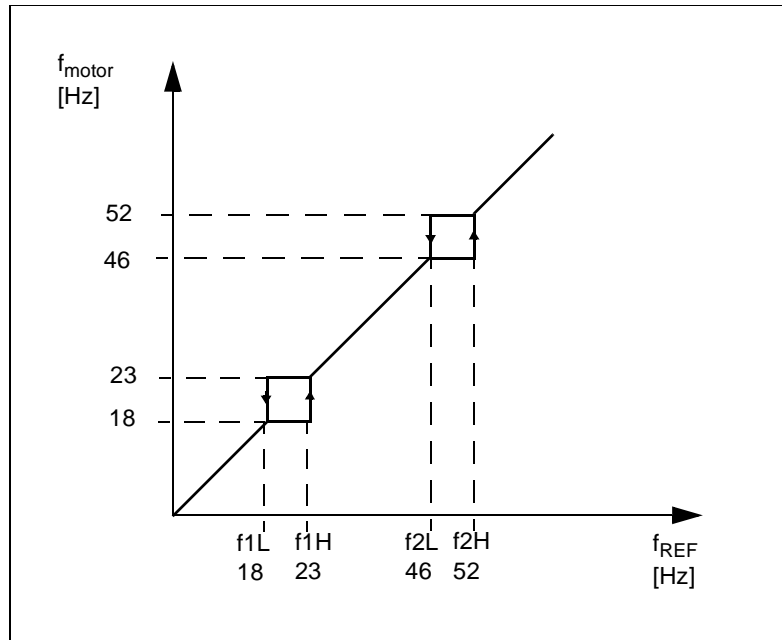



Figure 7-4 Example of critical frequencies setting.

The following is an alternative way to enter the LOW and HIGH settings for critical frequency:

- Run the drive with external reference.
- Using the analog input, set the frequency to the critical frequency LOW value.
- Go to parameter CRIT f1L on Page 2.
- Press and hold the  key for three seconds.
- The ACS 300 will respond by updating the frequency setting to the current value. The CRIT f1L is now set.
- Increase the analog input reference so that the output frequency is just above the critical frequency span.
- Go to parameter CRIT f1H on Page 2.

Chapter 7 - Drive Parameters

- Press and hold the  key for three seconds.
- The ACS 300 will respond by updating the frequency setting to the current value. The CRIT f1H is now set.

Repeat the procedure for the second critical frequency range if necessary. To erase the critical frequencies, set both to 0 Hz.

IR COMP This parameter allows extra torque at speeds between 0.1 Hz and the nominal motor speed. The parameter differs from the AUTO BOOST option of the START parameter in that it is always valid in the 0.1 Hz to nominal motor speed range.

Keep the compensation voltage as low as possible for the application, as the motor will overheat rapidly or an overcurrent fault may occur if a high level of compensation is applied.

Small motors can take higher compensation than larger motors because the winding resistance is higher in small motors. If the motor must drive a load with a high starting torque, we recommend using AUTO BOOST starting. If you have trouble with motor overheating, use a motor with more poles and run at a higher frequency.

If the IR compensation is set too high, the motor can “saturate” and will not rotate at all, but will draw current.

OFF

No compensation wanted.

0.1 - 60 V

The compensation voltage given by the user.

AUTO

The compensation voltage is automatically given to maintain or reduce current accordingly.

Chapter 7 - Drive Parameters

Figure 7-5 illustrates the effect of IR compensation. Extra voltage is applied to the motor as shown. Voltage “a” is the IR compensation voltage. Frequency “b” is the nominal motor frequency (NOM FREQ). Voltage c is the nominal motor voltage (U_N).

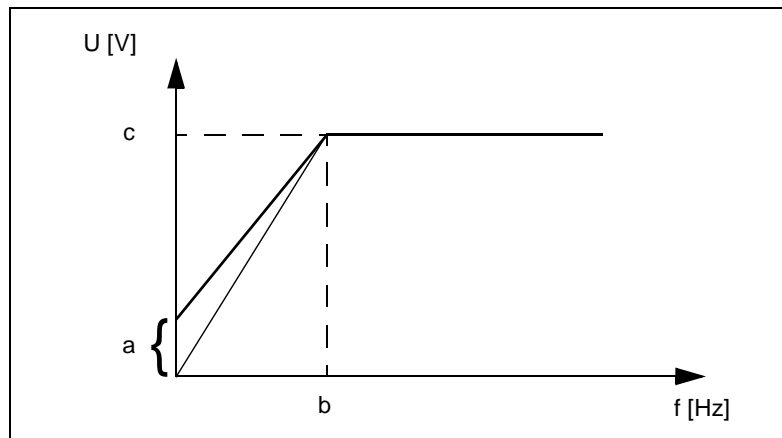

Figure 7-5 IR Compensation.

DC BRAKE When the STOP parameter is set to DC BRAKE or DEC+HOLD, this parameter sets the DC injection time in seconds. If the braking time is too short, the drive stops by coasting after the DC braking time has elapsed.

Note: Injecting DC current into the motor causes the motor to heat up. In applications where long DC BRAKE/DEC+HOLD times are required, externally ventilated motors should be used.

U/f RATIO The voltage to frequency ratio in the frequency range 0 Hz to nominal motor frequency can be set either LINEAR, SQUARE or OPTIM.

*Chapter 7 - Drive Parameters***LINEAR**

The voltage of the motor changes linearly with frequency in the constant flux range. Linear U/f (V/Hz) ratio is normally used in constant torque applications, or where the torque characteristics of the load are linear with speed.

SQUARE

Squared U/f (V/Hz) ratio is normally used in applications where the torque characteristic of the load is proportional to the square of the speed, such as centrifugal pump or fan systems.

OPTIM

The motor voltage is automatically controlled to minimize motor losses and noise. This setting is suitable for a drive which has slowly changing load torque and a motor which operates mainly below nominal load.

Note! Parameter MOTOR I must be set correctly for best results.

Note! OPTIM cannot be used in a system where two or more motors are connected in parallel to one ACS 300.

RESTART # Number of times the ACS 300 will automatically reset the fault and restart after any of the following faults: Undervoltage, Overvoltage, Overcurrent, Low AI-Signal, Unit Fault. For further information on fault tracing refer to “Chapter 8 - Fault Tracing” on page 71. If you select OFF, the automatic fault reset system is not in operation.

TEMP LIM The ACS 300 motor thermal protection (sometimes called I^2t or solid state overload protection) is activated by using the TEMP LIM parameter. When set to OFF, the motor overload protection is deactivated. The TEMP LIM and MOTOR I parameters define the continuous safe operating area for the motor, as illustrated in Figure 7-6.

Chapter 7 - Drive Parameters

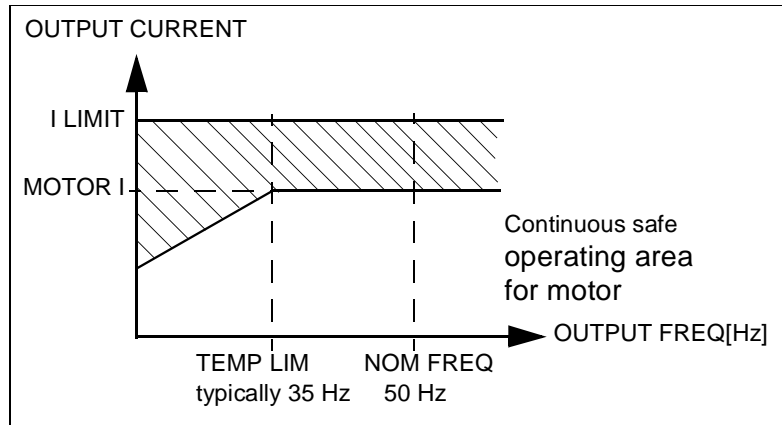

Figure 7-6 Motor thermal protection.

When the motor current exceeds the level determined by the safe operating area, the ACS 300 will begin calculating excessive temperature rise in the motor. When the ACS 300 has determined that the motor has exceeded its allowable temperature rise, it will stop the motor and indicate a “MOTOR TEMP” fault. The fault can be reset, when the motor has cooled down to a safe temperature. The ACS 300 will continue to calculate the motor temperature even if the motor is not running. If the ACS 300 is disconnected from the input power, the overload protection calculation is reset, and the motor is assumed to be at ambient.

The motor thermal protection function is designed to protect motors even at low speeds by decreasing the allowable operation current. This is necessary as the motor’s cooling fan becomes less efficient at low speeds.

For standard 50 Hz squirrel cage motors typical value for this parameter is 35 Hz.

MOTOR I Nominal motor current at full load as indicated on the motor rating plate. See U/f RATIO, TEMP LIM and Figure 7-6. This parameter does not need to be set if TEMP LIM is set to

Chapter 7 - Drive Parameters

OFF and OPTIM U/f RATIO is not used. MOTOR I does not restrict the I LIMIT parameter.

DIR If DIR parameter is set to FWD ONLY, local and external direction commands are disabled and the motor rotational direction is fixed to forward.

AI-FAULT This parameter allows you to disable Analog Input signal fault detection. If AI-FAULT is set to DISABLE and the reference minimum is set to 2 V / 4 mA, CUSTOM or JOYSTICK 2 V / 4 mA, the reference is set according to 2V/ 4mA input when the control signal is lost. Analog input fault is not indicated and not stored in Fault History.

1. **RELAY** This parameter allows you to select the information indicated with Relay Output. Factory setting for RELAY 1 is fault function. Factory setting for RELAY 2 is code number 7, "Motor is running".

Code	Function
1	Fault
2	Power
3	I>Current limit
4	>Frequency limit
5	<Frequency limit
6	Motor is running forward
7	Motor is running
8	Motor overtemperature trip
9	Under panel control (LOCAL)
10	None
11	Fault (-1)

1 (Fault)

Relay is de-energized (and the Fault LED on the Control Panel illuminates), when a fault occurs.

*Chapter 7 - Drive Parameters***2 (Power)**

Relay is energized all the time (after initialization of the program).

Note! The relay is energized when this function is selected.

3 (I>Current Limit)

Relay is energized for a minimum of 250 ms whenever the output current exceeds I LIMIT. The time is for hysteresis and slow response of indication devices. Relay is de-energized when current is reduced below I LIMIT.

4 (>Frequency limit)

Relay is de-energized when the output frequency exceeds the value selected with parameter F SUPERV. Relay is energized when output frequency is below (F SUPERV - hysteresis). If F SUPERV is greater than 10 Hz the hysteresis is 2 Hz, otherwise hysteresis is 20 % of F SUPERV.

5 (<Frequency limit)

Relay is de-energized when the output frequency falls below the value selected with parameter F SUPERV. Relay is energized when output frequency is more than (F SUPERV + hysteresis). If F SUPERV is greater than 10 Hz the hysteresis is 2 Hz, otherwise hysteresis is 20 % of F SUPERV.

6 (Motor is running forward)

Relay is de-energised, when the motor is running and the direction is forward (according to the status of the modulator, not the reference or switches).

7 (Motor is running)

Relay is energized, when the motor is running (according to the status of the modulator, not the reference or switches).

8 (Motor overtemperature trip)

Relay is de-energised while the Motor Overtemp fault is active. Other faults can also be active while the relay is de-energised.

*Chapter 7 - Drive Parameters***9** (Under Panel Control (LOCAL state))

Relay is de-energised while the LOCAL state is active (REMOTE LED on the panel is not illuminated).

10 (None)

Relay is de-energised.

Note! Relay is de-energised, if this function is selected while the relay is energised.

11 (Fault (-1))

Relay is energised (and the fault LED on the Control Panel illuminates), when a fault is active.

Note! When planning the application of the programmable relay, do not forget that the relay is always de-energised when the drive power is shut off.

F SUPERV F SUPERV is the frequency limit for relay functions 4 and 5. Please look at the previous parameter.

Page 3 parameters

*PAGE 3 (*P4)* Press  to change to Page 4.

DC HOLD This parameter enables the DC HOLD feature. There are three options for using this parameter.

0 (Off)

DC HOLD is disabled.

1 (Normal)

This option provides “less” DC current and hold torque to the motor than option 2. We recommend that you try this option first to see if you can get enough hold.

2 (Strong)

This option provides adequate DC current and hold torque to the motor.

Chapter 7 - Drive Parameters

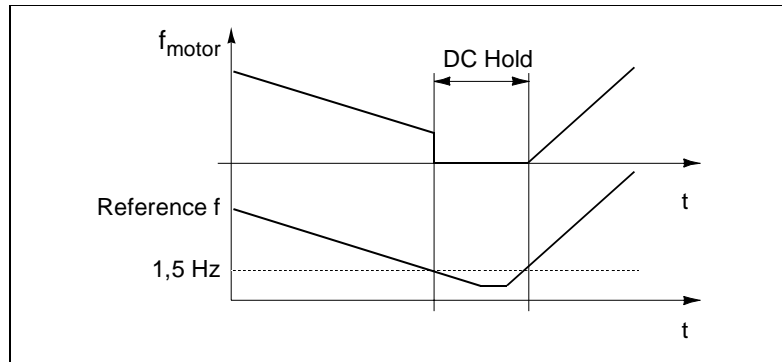

Figure 7-7 DC Hold.

When both reference and output frequency drop below 1.5 Hz, the ACS 300 will stop generating sinusoidal current and inject DC into the motor. When the reference frequency rises above 1.5 Hz, the DC will be removed and normal ACS 300 function resumed.

DC Hold has no effect if the Start signal is deactivated.

Note: Injecting DC current into the motor causes the motor to heat up. In applications where long DC Hold times are required, externally ventilated motors should be used. DC Hold cannot keep the motor shaft totally from rotating if a load torque is applied to the motor.

PARAM SET Selecting extended I/O configuration. When you want to use page 4 parameters, parameter PSET must be set to "2" and DI5 must be active.

1

Page 4 parameters ignored.

2

Page 4 parameters are used if DI5 is active.

Chapter 7 - Drive Parameters

PI-GAIN This parameter defines the gain of PI Controller. The setting range is 0 to 800 %. If the value is 0 %, the PI Controller is inactive. Changing of PI-GAIN from 0 is possible only when start is inactive. The following table shows how the output frequency changes to a 10 % change in error and a 50 % change in error with different gain selections.

PI-GAIN	Output frequency change for a 10 % change in error	Output frequency change for a 50 % change in error
50 %	0.75 Hz	3.75 Hz
100 %	1.5 Hz	7.5 Hz
300 %	4.5 Hz	22.5 Hz

Some points of view must be taken in consideration when this parameter is active:

- The Local Ref parameter is not displayed.
- The analog input, AI is used only as the actual value (process feedback) input. PI-REF is changed through the control panel when the drive is in the local mode and as described below when the drive is in the remote mode.
- The texts on the control panel display for constant frequencies will be CR1, CR2 and CR3. CR = Constant Reference. The unit is %. With these parameters you can give constant reference values in the remote mode.
- Joystick control does not operate. On the other hand PI Control cannot be selected while Joystick control is active.
- Custom settings have no effect.
- The rotation direction cannot be changed.
- Critical frequency ranges are ignored.

PI-ITIME Defines the integral time of PI Controller. The setting range is 0.0 to 320.0 s. PI Controller operates as a P Controller when the parameter value is 320.0 s.

Chapter 7 - Drive Parameters

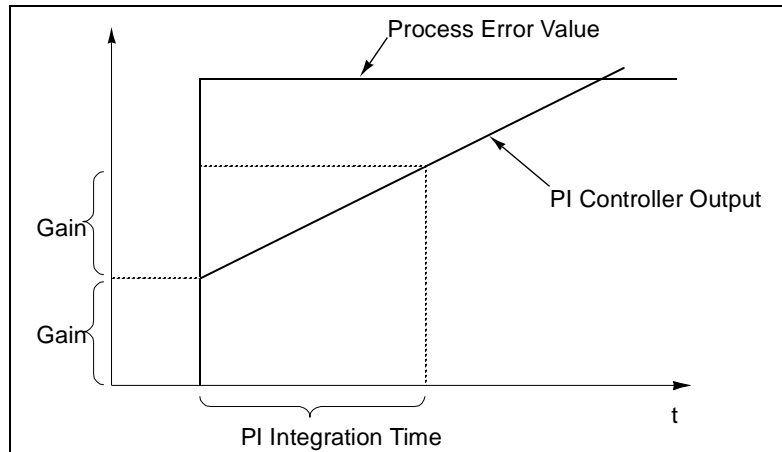

Figure 7-8 PI Controller Gain, I-Time and Error Value.

PI-SCMIN Minimum scaling factor of the actual value. The setting range is -999.9 to 999.9 %. The value of PI-SCMIN can be higher than the value of PI-SCMAX. See the example A in Figure 7-9. In this example, PI-SCMIN is 400 % and PI-SCMAX is -300 %.

PI-SCMAX Maximum scaling factor of the actual value. The setting range is -999.9 to 999.9 %. See Figure 7-9 and Figure 7-10. In this example B, 4 V is equivalent to 0 % and 8 V is equivalent to 100 %. You can get the corresponding values for parameters PI-SCMIN and PI-SCMAX from the straight line in Figure 7-9. In the example B, PI-SCMIN is -100 % and PI-SCMAX is 150 %.

Chapter 7 - Drive Parameters

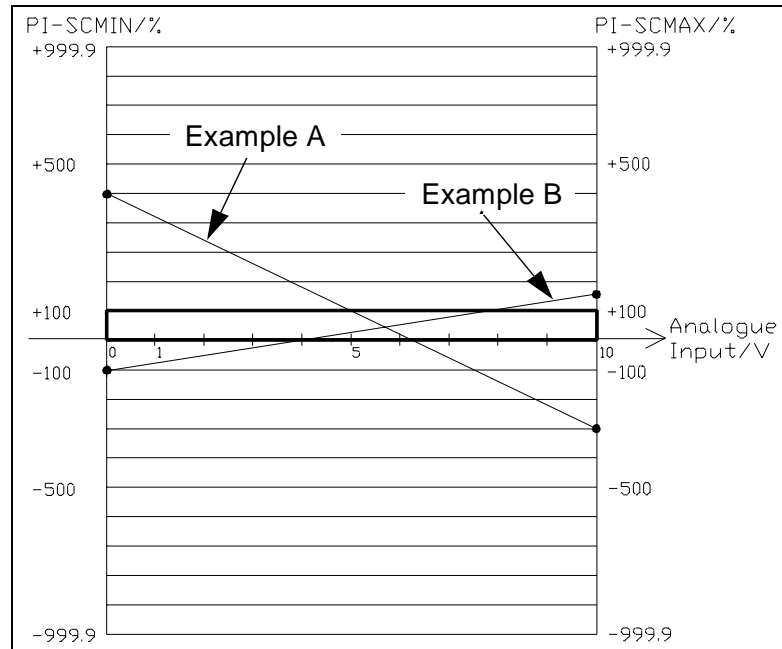

Figure 7-9 PI Controller, the scaling of actual value.

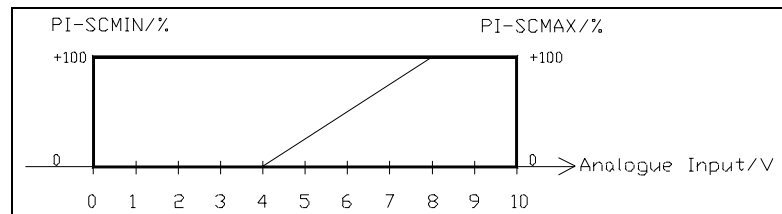

Figure 7-10 Operating range, example B.

PI-REF Reference value for the PI Controller. The setting range is 0.0 to 100.0. It is not recommended to set this parameter value higher than 0.8 x measuring scale. This value can be changed through the control panel when in local mode. When the drive is in remote mode this parameter is displayed only.

Chapter 7 - Drive Parameters

VERSION Parameter Version displays the software version. For example the software version could be CDS02B.2.

P. LOCK Parameter Lock prevents unauthorized persons from altering the parameters.

OPEN

The Parameter Lock is open allowing the parameter values to be changed.

LOCKED

The Parameter Lock is active. The parameter values cannot be changed, except parameters OUTPUT f and LOC REF.

Page 4 parameters

PAGE 4 (*P1) Press  to change to Page 1.

Parameter set 2 parameters. These parameters are effective when parameter PSET is set "2" and digital input 5 is active. These parameters are similar to the respective in Pages 1 and 2.

Chapter 7 - Drive Parameters

Chapter 8 - Fault Tracing

This chapter describes the ACS 300 fault indications and fault memory. It also explains how to trace faults.

Fault Indications

The ACS 300 continuously monitors itself for faulty operation. If a fault condition should arise, a fault indication is displayed, the fault LED illuminates and the ACS 300 waits for the operator to acknowledge the fault before resuming operation.

Fault Resetting

An active fault can be reset either by pressing the keypad  button, deactivating the Start input (DI1) or switching the input voltage off for a while. When the fault has been removed, the ACS 300 will resume normal operation. If the fault has not been removed, the ACS 300 will trip again. For automatic fault reset, refer to parameter RESTART # on page 61.

Note! If the Start command is active and the fault has cleared, fault resetting starts the drive.

Some faults require you to cycle the power off and on once before the fault can be cleared. Proper fault reset action is given in “Fault Tracing” on page 74.

Fault Memory

When a fault is detected, it is stored so that it can be reviewed at a later date. The last three faults are stored on Page 1 parameter FAULT MEMORY.

Scrolling through the FAULT MEMORY does not erase the FAULT MEMORY. The oldest fault indication is automatically erased when a new fault occurs.

Note! Undervoltage fault is stored in FAULT MEMORY if the fault occurs and automatic restart (RESTART #) is off. If the automatic restart is on, the undervoltage fault is not stored in the FAULT MEMORY unless the fault persists after restart.

Chapter 8 - Fault Tracing

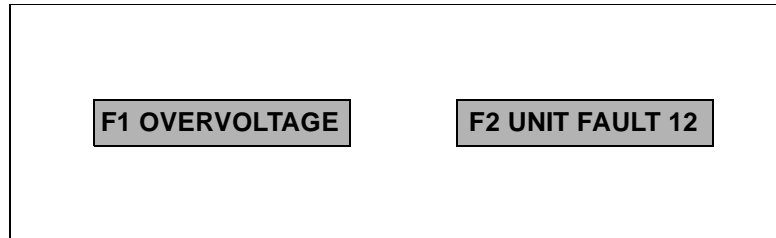





Figure 8-1 Examples of fault indications in the fault memory.

Fault Tracing

Table 8-1 shows the displayed fault text (in the FAULT MEMORY); the probable cause of the fault; and advice for correcting the fault.



 = Press once to reset fault.

 = Switch power off to reset fault.



Fault Memory can be erased by pressing simultaneously  button and  - button while reviewing Fault Memory. Erasing will clear all three fault records.

Chapter 8 - Fault Tracing





Table 8-1 Fault tracing.

Fault indication	Possible cause	Remedy
(1) NO FAULT	This message only appears in the fault memory.	
(2) OVERVOLTAGE 	DC bus voltage has exceeded 130 % nominal voltage. Over-voltage is generally caused when the motor runs as a generator in drives where the load inertia is high and the deceleration time is set low. Too high supply voltage may also be the cause.	<ul style="list-style-type: none"> • In case of temporary supply voltage peak, reset and start. • Use longer deceleration time or • Use coasting stop function if it is compatible with the application. • If short deceleration time is needed, use external Braking options. • Check supply voltage (400 V)
(3) UNDERVOLTAGE 	DC bus voltage has gone below 65 % of the nominal voltage. Most common reason for low voltage trip is failure in the AC line supply, loss of phase or "brown out" condition.	<ul style="list-style-type: none"> • In case of temporary supply voltage drop, reset and start. • Check AC line input.
(4) OVERCURRENT 	Motor may be too small for the application. Motor current is too high due to <ul style="list-style-type: none"> • high load inertia/short ramp times • sudden load torque change • stalling motor • motor wiring or motor failure • long motor cable 	<ul style="list-style-type: none"> • Check ramp times • Remove mechanical problem causing increased load torque. • Check cables and motor • Use optional output chokes • Check dimensioning, use larger ACS 300 and motor if necessary.

Chapter 8 - Fault Tracing

Fault indication	Possible cause	Remedy
(5) LOW AI-SIGNAL 	Analogue input less than 2 V/ 4mA and minimum has been set to 2 V/4 mA or Analogue Input less than selected "customized minimum".	<ul style="list-style-type: none"> • Input reference has failed or control wire is broken. Check the reference circuit.
(6) PANEL COM ERR 	Control Panel was removed when control was in Local mode. Due to safety reasons, the drive stops in this fault condition.	<ul style="list-style-type: none"> • Attach the Control Panel and reset the fault, then change to Remote mode and remove Panel. • Use remote (wired) controls to reset the fault, then start and run with remote controls • There might be a loose contact. Check the panel connection.
(10) BUS COMM FLT	Bus communication error	<ul style="list-style-type: none"> • Check bus connections
(7) UNIT FAULT 	ACS 300 heatsink temperature too high.	CHECK: <ul style="list-style-type: none"> • Heatsink dissipation • Dust and dirt • Air flow • Fan • Ambient temperature • Reduce switching frequency. • Check load current
	Ground faults or short circuits.	CHECK: <ul style="list-style-type: none"> • Terminals • Motor • Wiring
	With frame size R2 high load inertia / short ramp	CHECK: <ul style="list-style-type: none"> • Ramps times • Remove mechanical problems • Dimensioning

Chapter 8 - Fault Tracing

Fault indication	Possible cause	Remedy
(8) UNIT FAULT 	Inverter control unsuccessful.	<ul style="list-style-type: none"> Switch power off. If fault persists, contact your nearest ACS 300 supplier.
(9) MOTOR TEMP 	ACS 300 has calculated that the motor is overheated. As the fault indication is based on calculated temperature rise, the motor may be within safe temperature range.	<ul style="list-style-type: none"> Check the motor temperature. If it is within acceptable range, adjust TEMP LIM and I LIMIT and restart. Check the motor sizing with respect to the load.
(11) UNIT FAULT (12) UNIT FAULT (13) UNIT FAULT 	Charging circuit defective. Failure in reading Analogue/ Digital input. Modulator error.	<ul style="list-style-type: none"> Contact your nearest ACS 300 supplier.
(14) UNIT FAULT (15) UNIT FAULT 	EEPROM error Identification error	<ul style="list-style-type: none"> Disconnect the ACS 300 from the AC line. Wait 30 s. Reconnect the ACS 300 to the AC line and start. Contact your nearest ACS 300 supplier.
THE PANEL DOES NOT FUNCTION		<p>CHECK:</p> <ul style="list-style-type: none"> the contrast of the panel the panel connection

Chapter 8 - Fault Tracing

Fault indication	Possible cause	Remedy
THE DRIVE DOES NOT FUNCTION CORRECTLY IN REMOTE CONTROL		CHECK: <ul style="list-style-type: none"> • the polarity of the signals • the position of switch S1 • the position of jumper X5
CONTROL PANEL	Processor incompatible with Control Panel.	<ul style="list-style-type: none"> • Check the connection between the processor and the panel.
	Control card error	<ul style="list-style-type: none"> • Contact your nearest ACS 300 supplier.
WRITE -> ACS ERROR VERSION MISMATCH	Mismatch of ACS 300 software. Note! Parameter copying unsuccessful.	<ul style="list-style-type: none"> • Set the parameters manually.
OUTPUT FREQUENCY < REFERENCE FREQUENCY	<ul style="list-style-type: none"> • wrong parameter values • too much load • wrong motor connection 	CHECK: <ul style="list-style-type: none"> • supply voltage (400 V series) • I LIMIT high enough • IR COMP not too high • motor connection Star/Delta • ACS 300 sizing with respect to the load

Note! If the fault persists, contact the nearest ACS 300 supplier.

Chapter 9 - Technical Data

Incoming Power

Voltage	1 and 3 phase 208 to 240 V	±10 %
	1 and 3 phase 200 to 240 V	-7% +10%
	3 phase 380 to 480 V	±10 %
Frequency	48 to 63 Hz	
Fundamental power factor	approximately 0.98	

Output Power

Voltage	3 phase, 0 to $V_{AC\ LINE}$	
Frequency	0 to 500 Hz	
Switching frequency f_s	1.0 to 16.0 kHz	
Continuous load capacity, constant torque at a maximum ambient temperature of 50 °C	ACS 300 rated current	see Figure 2-1
Overload capacity at a maximum ambient temperature of 50 °C	Constant torque	$1.5 * I_N$ 1 min every 10 min, if switching frequency < 8 kHz ¹⁾
	Starting duty	$1.5 * I_N$ 1 min every 10 min, if switching frequency < 8 kHz ¹⁾
Nominal motor voltage	200 to 240 V 360 to 500 V	
Acceleration time	0.1 to 1800 s	see Chapter 7 - Drive Parameters
Deceleration time	0.1 to 1800 s	see Chapter 7 - Drive Parameters

¹⁾ Check type-specific, refer to Table 1-1 and Table 1-2.

Chapter 9 - Technical Data

Environmental Limits

Ambient operating temperature	0 - 40 °C	output current I_N
	40 - 50 °C	see derating curves, Figure 2-1
Storage temperature	-25 °C to 70 °C	
Transport temperature	-40 °C to 70 °C	
Cooling method	natural air circulation	ACS 311-1P1-1 and 1P6-1
	internal fan	Other types
Relative humidity	max. 95 %	no condensation allowed
Altitude	<1000 m ASL (100 % load capacity)	1.0 % derating every 100 m above 1000 m ASL
Enclosure classes	IP 20	without top cover
	IP 21	with top cover

External Control Connections

analog input	frequency reference		
	Voltage reference	0 (2) to 10 V	200 k Ω single ended
	Current reference	0 (4) to 20 mA	250 Ω single ended
	Response time	min 10 ms	typically 30 ms
	Resolution	10 bit	
	Potentiometer reference	10 V -0/+2%	10 mA Short circuit protected
Auxiliary voltage	+24 V DC \pm 15%	max. 50 mA	

Chapter 9 - Technical Data

One analog output	Current output	0 (4) to 20 mA	$R_L < 500 \Omega$
	Source (selected by parameter)	Output frequency	scaled 0 to maximum frequency
		Output (motor) current	scaled 0 to $1.5 \times I_N$
		Output frequency reference	scaled 0 to maximum frequency
	Accuracy	Frequency outputs $\pm 2 \%$	
		Motor current output $\pm 10 \%$	
	Ripple	1 %	
	Response time	50 ms	
Five digital inputs	Refer to Chapter 4, on page page 25 for a description of the functions of the digital inputs	Max input 48 V $10k\Omega < Z_{IN} < 30k\Omega$	$V_{IN \text{ low}} < 3V$ $V_{IN \text{ high}} > 10 V$
Two relay outputs	Programmable, refer to Chapter 7 Page 2 parameters 225 and 226		
	Max switching voltage	250 V AC/ 150 V DC	
	Max switching current	8 A 250 V AC /24 V DC	
	Max switching power	2000 VA / 250 V AC 192 W / 24 V DC	
	Max continuous current	2 A rms	
Control common	Frame ground	default setting	see page 21
	Floating	alternate	see page 21

Chapter 9 - Technical Data

Protection

Short-circuit overcurrent trip limit	$3.5 \times I_N$
Output current regulation limit	$0.5 - 1.5 \times I_N$
Overvoltage trip limit	$1.35 \times U_{240}$, $1.3 \times U_{480}$
Undervoltage trip limit	$0.65 \times U_N$
Overtemperature limit	90 °C, heatsink
Auxiliary voltage	short-circuit protected
Ground fault protection	protects only the ACS 300 when an ground fault occurs at motor output

Accessories

Keypad Control Panel	ACS300CDP-PANEL
Control Panel Remote Mounting Kit, NEMA 4 with 10 foot cable	ACD200CBL
Braking resistor	R0, R1, R2
External braking chopper	R2
RFI Filter	R0 Type S-492-10, (R1,R2 standard)
RS 232 adapter	Release pending
Fieldbus adapters	Release pending

Appendix A - Product Conformity in EEA

General Information	<p>This appendix contains information regarding conformity with the requirements of the European Economic Area. For additional information, refer to ABB Technical Guide No. 2, <i>EU Council Directives and Variable Speed Drives</i>, and ABB Technical Guide No. 3, <i>EMC Compliant Installation and Configuration for a Power Drive System</i>.</p> <p>Information given here is applicable only for the ACS 300 Frequency Converter with which this information is attached. This information may not be applicable for other ACS 300 Frequency Converters or for ACS 300 User's Manuals with later revisions than Rev B.</p>
Electromagnetic Compatibility, EMC	<p>This information is valid for the products with CE marking.</p> <p>Electromagnetic Compatibility (EMC), Directive 89/336/EEC, as Amended by 93/68/EEC</p> <p>The frequency converters of series ACS 300 are in conformity with the harmonised standards as specified below and following the provisions of this Directive, provided that the installation of the converter is done according to instructions and requirements given in this User's Manual:</p> <p>Chapter 2 - Mechanical Installation Chapter 3 - Power Connections Chapter 4 - Control Connections</p>
ACS 301 Frame Size R1 ACS 311 Frame Size R0	<p>The converters with type codes ACS 301-1P6-3, ACS 301-2P1-3, ACS 301-2P7-3, ACS 301-4P1-3, ACS 301-4P9-3, ACS 301-6P6-3, ACS 301-2P1-1 (1-phase), ACS 301-2P7-1 (1-phase), ACS 301-4P1-1 (1-phase) as well ACS 311-1P1-1 and ACS 311-1P6-1 used in the connection of an external RFI Filter, type DUCATI S-</p>

Appendix A - Product Conformity in EEA

492-10 are in conformity with the following harmonised standards:

EN 50081-1: 1992	EMC, Emission	Residential, commercial and light industry
EN 50081-2: 1993	EMC, Emission	Industrial environment
EN 50081-2: 1995	EMC, Immunity	Industrial environment

The converter can be used in residential, commercial and light industrial or industrial electromagnetic environments.

ACS 301 Frame Size R2 The converters with type codes ACS 301-8P7-3, ACS 301-012-3 and ACS 301-016-3 are in conformity with prEN 61800-3: Adjustable speed electrical power drive systems - Part 3: EMC product standard including specific test methods 1995 approved at voting 15.03.1996 to use in first environment class conditions marketed in the restricted distribution mode as well as in the second environment conditions.

ACS 311 The Converters of Series ACS 311 (without RFI-filter) are in conformity with the following harmonised standard

EN 50082-2: 1995	EMC, Immunity	Industrial environment
------------------	---------------	------------------------

The converters are not EMC compliant as such concerning electromagnetic emissions.

CE marking in these converters refer to Low Voltage Directive (73/23/EEC, as amended 93/68/EEC) only.

Low Voltage Directive

Low Voltage Directive 73/23/EEC, as amended by 93/68/EEC.

ACS 300 Frequency Converters including all types, as specified in User's Manual, Table 1-1 and Table 1-2, are in conformity with the following harmonised standard:

Appendix A - Product Conformity in EEA

EN 60204-1, October 1992, following the provisions of this Directive with the exceptions per following Clauses of EN 60204-1:

Clause 5.3.1	Supply disconnecting (isolating) device - manufacturer of the machine is responsible of the installation - please, refer to "Disconnect Device" on page viii.
Clause 6.2.1	Protection by enclosures - degree of protection is chosen according to the place of use - please refer to "Environmental Limits" on page 80.
Clause 9.2.2	Stop functions - manufacturer of the machine is responsible of the installation - please, refer to "Emergency Stop Devices" on page viii.
Clause 9.2.5.4	Emergency stop - manufacturer of the machine is responsible of the installation - please, refer to "Emergency Stop Devices" on page viii.
Clause 13.3	Degrees of protection - degree of protection is chosen according to the place of use - please, refer to "Environmental Limits" on page 80

Machinery Directive

Machinery Directive 89/392/EEC, Art. 4.2 and Annex II, Sub B.

ACS 300 Frequency Converters including all types, as specified in User's Manual, Table 1-1 and Table 1-2

- are intended to be incorporated into machinery to constitute machinery covered by this Directive, as amended
- do therefore not in every respect comply with the provisions of this Directive
- the following clauses of harmonised standards have been applied:

EN 60204-1: October 1992	with exceptions as described in the connection of Low Voltage Directive (see above)
--------------------------	---

Appendix A - Product Conformity in EEA

- the following clauses of technical standards and specifications have been used:

EN 60529: 1991	
IEC 664-1: 1992	Installation Category III, Pollution Degree 2
IEC 721-3-1: 1987	Combination of classes 1K4/1Z2/1Z3/1Z5/1B2/1C2/1S3/1M3
IEC 721-3-2: 1985	Combination of classes 2K4/2B2/2C2/2S2/2M3
IEC 721-3-3: 1987	Combination of classes 3K3/3Z2/3Z4/3B1/3C2/3S2/3M1

Furthermore it is not allowed to put the equipment into service until the machinery into which it is to be incorporated or of which it is to be a component has been found and declared to be in conformity with the provisions of this Directive and with national implementing legislation, i.e. as a whole, including ACS 300 frequency converters.

Installation

Mains Cable

Note! A three-conductor screened cable (single phase and neutral with protective earth) or four-conductor (three-phase with protective earth) are recommended for the mains cabling, see Figure A-1. Dimension the cables and fuses in accordance with the input/output current. Refer to Table A-1. *Always pay attention to local legislation* when sizing the cables and fuses.

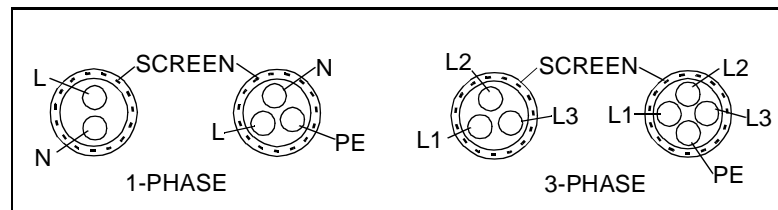

Figure A-1 Permissible mains cables.

Appendix A - Product Conformity in EEA

Motor Cable

A symmetrical three conductor screened cable (three phase with concentric protective earth) is recommended, because unscreened cables may lead to unwanted problems of electrical noise emission. See Figure A-2.



Figure A-2 Recommended motor cables.

Note! To avoid disturbance, install the motor cable away from the control cable route. Avoid long runs parallel with control cables.

The rapid voltage changes cause capacitive current in the motor cable. This current increases with the switching frequency and motor cable length. This phenomenon can cause substantially higher current measured by the ACS 300 than the actual motor current, and can cause over-current tripping. Do not exceed cable lengths of 100 m. The capacitive current can be diminished with an output choke coil. If the cable length exceeds 100 m, please contact your local distributor or ABB office.

Cable Installation

To suppress the RFI emission below the limits mandated by the EMC Directive, it is important to pay attention to the following:

The mains, motor and brake cables must be clamped at the entry point, see Figure A-3 and Figure A-4. There is a clamping plate for that purpose. Make it certain that the screens of the cables make solid contacts to both parts of the clamp. Leave the individual unscreened wire loops

Appendix A - Product Conformity in EEA

between the clamp and the screw terminals as short as possible. Route the mains wires away from the others.

Connect the mains and motor cables according to the layout in Figure 3-1 on page 18.

In case the shield is used also as a protective conductor, you must connect it both to the clamp and to the PE terminal. Clamping alone is insufficient.

Note! In addition to clamping the motor cable screen to the clamping plate at the ACS 300, connect the screen to motor earth at the motor.

Clamp the control cable at the entry point, see Figure A-3 and Figure A-4. Make it certain that the screen of the cable makes a solid contact to both parts of the clamp. Leave the individual unscreened wire loops between the clamp and the screw terminals as short as possible. Route the control cable away from the motor cable. Control cables must be multi-core cables with braid shield.

Appendix A - Product Conformity in EEA

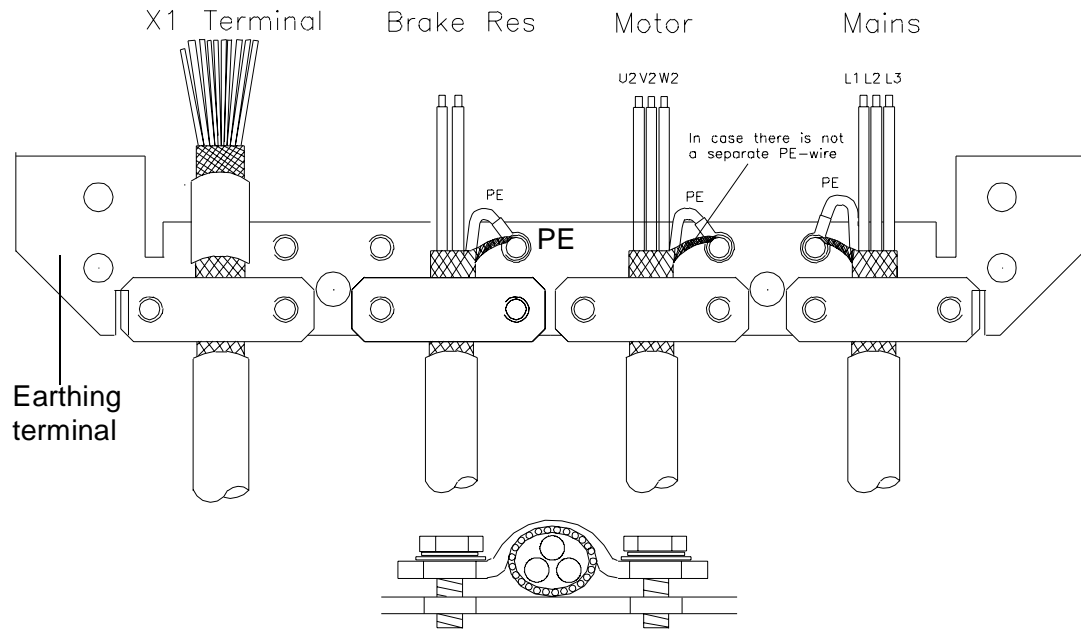

Figure A-3 The principle of cable connections for frame sizes R0 and R1 (cable connection order according to frame size R1)

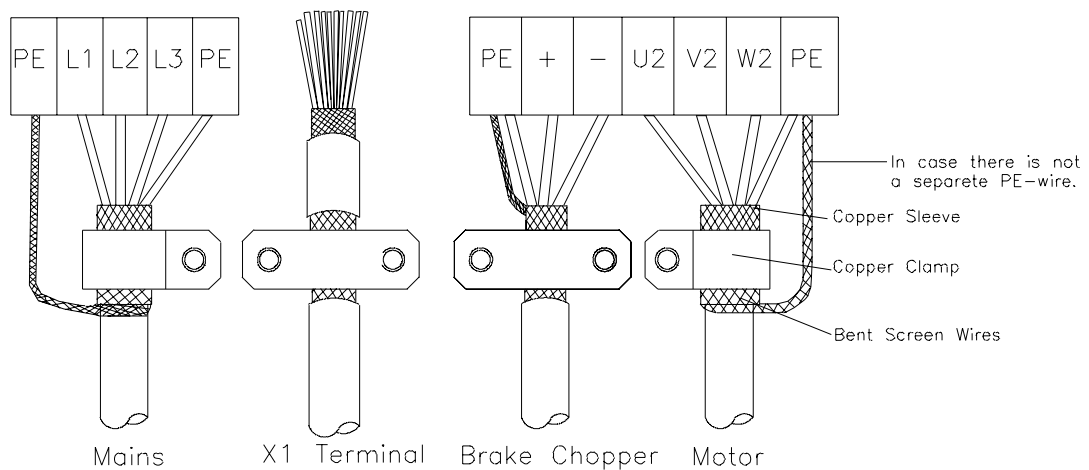

Figure A-4 Cable connections for frame size R2.

Appendix A - Product Conformity in EEA

Table A-1 Cables and fuse recommendations, 200-240 V.

Type designation 208-240 V	Rated input current I_1 [A]		Recommended input fuse [A]		Recommended mains and motor cable [mm ²]	
	1 phase	3 phase	1 phase	3 phase	1-phase	3-phase
ACS 311-1P1-1	6.6	-	10	-	2*1.5+1.5	3*1.5+1.5
ACS 311-1P6-1	8.9	-	10	-	2*1.5+1.5	3*1.5+1.5
ACS 301-2P1-1	12.2	-	16	10	2*2.5+2.5	3*1.5+1.5
ACS 311-2P1-1	12.2	8.4	16	10	2*2.5+2.5	3*1.5+1.5
ACS 301-2P7-1	15.7	-	16	10	2*2.5+2.5	3*1.5+1.5
ACS 311-2P7-1	15.7	9.8	16	10	2*2.5+2.5	3*1.5+1.5
ACS 301-4P1-1	22.4	-	32	16	2*6+6	3*1.5+1.5
ACS 311-4P1-1	22.4	12.9	32	16	2*6+6	3*2.5+2.5
ACS 3_1-4P9-1	-	10.6	-	16	-	3*6+6
ACS 3_1-6P6-1	-	14.4	-	16	-	3*6+6
ACS 3_1-8P7-1	-	21.0	-	25	-	3*10+10

Table A-2 Cables and fuse recommendations, 380-480 V.

Type designation 380-480 V	Rated input current I_1 [A]	Recommended input fuse [A]	Recommended mains and motor cable [mm ²]
	3 phase	3 phase	3 phase
ACS 3_1-1P6-3	3.0	10	3*1.5+1.5
ACS 3_1-2P1-3	3.9	10	3*1.5+1.5
ACS 3_1-2P7-3	5.0	10	3*1.5+1.5
ACS 3_1-4P1-3	7.5	16	3*2.5+2.5
ACS 3_1-4P9-3	9.1	16	3*2.5+2.5
ACS 3_1-6P6-3	12.1	16	3*2.5+2.5
ACS 3_1-8P7-3	10.6	16	3*6+6
ACS 3_1-012-3	14.4	16	3*6+6
ACS 3_1-016-3	21	25	3*10+10

ACS300-US-04
3AJA 489002B3207 R0101 REV B
EFFECTIVE: 1/1/1998

ABB Industrial Systems Inc.
16250 W. Glendale Drive
New Berlin, WI 53151
USA
Telephone: (414) 785-3416
(800) 752-0696
Telefax (414) 785-0397